

REVISION RECORD

REV	ECN	DESCRIPTION	DRFT	DATE
-----	-----	-------------	------	------

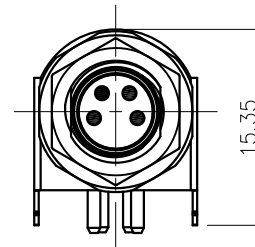
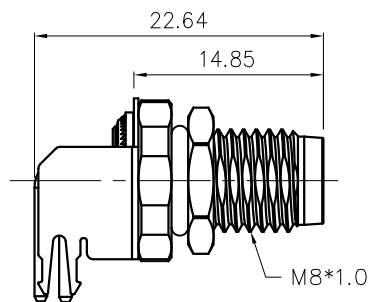
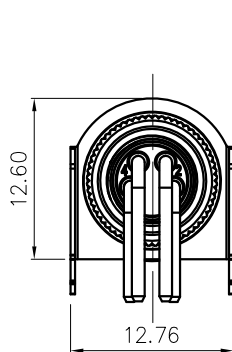

SRSR-M8A-XXP-MM-SF7003-00A(H)

Pin number:03,04

NOTES:

- Rated voltage/current : 3pin: 60V / 3A
4pin: 60V / 3A
- Withstanding voltage : 3,4pin: AC850V/1Min
- Levels of protection: IP67
- Wire connection mode: soldering(PCB)
- Operating temperature: -40°C~+105°C
- For Panel Thinkness Range: 2.0~3.0mm
- For PCB Thinkness Max: 1.6mm
- RoHS Compliance
- Tolerance :

.X	±0.25mm
.XX	±0.1mm
∠	±1°

3pin A Coding

4pin A Coding

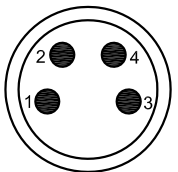
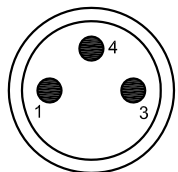

Pin Assignment Front View

Pin Assignment Front View

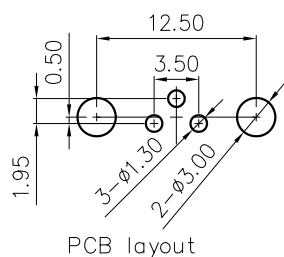

PCB layout

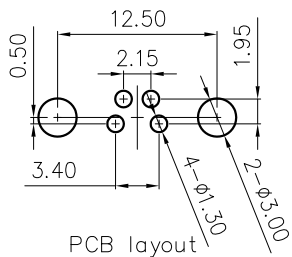

PCB layout

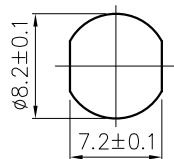

Panel cut

DETACHED LISTS	PART NO.: SRSHM8AXXPMMSF700300AH		宁波高松电子有限公司 NINGBO DEGSON ELECTRICAL CO., LTD	
	APPD:	NAME: SRSH-M8A-XXP-MM-SF7003-00A(H)		
	CHKD:	TITLE: CUSTOMER DRAWING		
	DRFT: SQ 2019.05.17	REV	SHEET 1/1	
 THIRD ANGLE PROJECTION		DRAWING NO.: XXXXXXX-XX-CXX	SCALE	1:1
		MM (INCH)	DO NOT SCALE DRAWING	