

# DF58-C-EN-IP

## User Manual

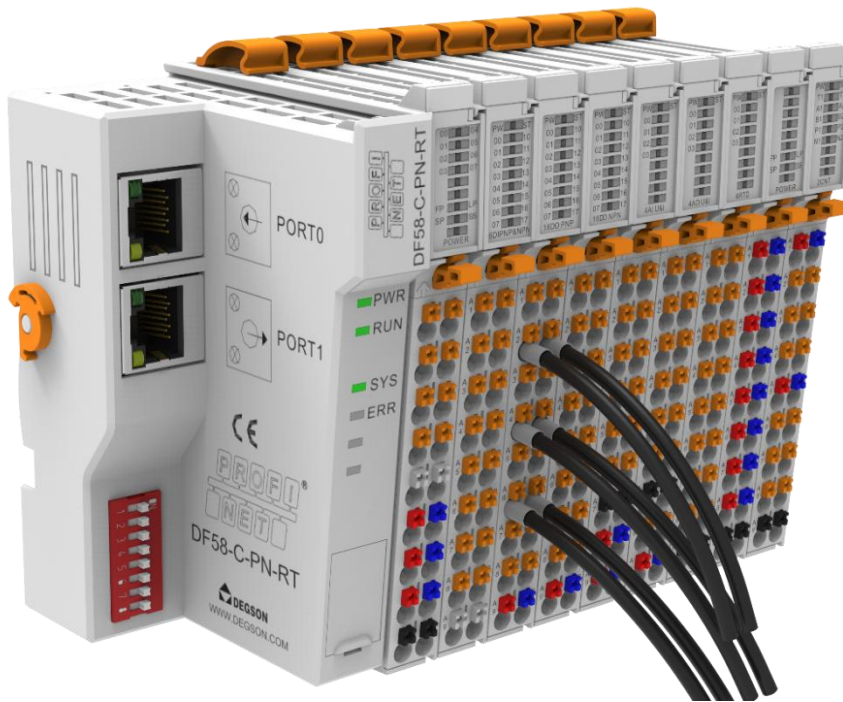

**Directory**

Directory .....	2
Preface .....	6
1. Product installation and disassembly .....	9
◆...1.1. Installation .....	9
◆...1.2. Grounding protection .....	9
◆...1.3. Disassembly method .....	10
1.3.1. Module disassembly .....	10
1.3.2. Terminal disassembly .....	10
1.3.3. Cold-pressed terminals .....	11
◆...1.4. Precautions .....	12
2. Fieldbus adapter .....	13
◆...2.1. EtherNet/IP fieldbus adapter (DF58-C-EN-IP).....	13
2.1.1. Specifications .....	14
2.1.2. Hardware interface .....	16
2.1.3. Mechanical installation .....	19
2.1.4. Parameter information .....	19
3. Expand the I/O module .....	24
◆...3.1. 16-channel digital input/24VDC/PNP&NPN (DF58-M-16DI-P/N).....	25
3.1.1. Specifications .....	26
3.1.2. Hardware interface .....	28
3.1.3. Module parameters .....	30
3.1.4. Mechanical installation .....	32

◆...3.2. 16-channel digital output/24VDC/PNP (DF58-M-16DO-P).....	33
3.2.1. Specifications .....	34
3.2.2. Hardware interface .....	36
3.2.3. Module parameters .....	38
3.2.4. Mechanical installation .....	40
◆...3.3. 16-channel digital output/24VDC/NPN(DF5-M-16DO-N) .....	41
3.3.1. Specifications .....	42
3.3.2. Hardware interface .....	43
3.3.3. Module parameters .....	46
3.3.4. Mechanical installation .....	48
◆...3.4. 4-channel analog input/voltage/current (DF58-M-4AI-UI-6).....	49
3.4.1. Specifications .....	50
3.4.2. Hardware interface .....	52
3.4.3. Module parameters .....	54
3.4.4. Mechanical installation .....	57
◆...3.5. 4-channel analogue output/voltage/current (DF58-M-4AO-UI-6).....	58
3.5.1. Specifications .....	59
3.5.2. Hardware interface .....	61
3.5.3. Module parameters .....	63
3.5.4. Mechanical installation .....	67
◆...3.6. 4-channel RTD measurement (DF58-M-4RTD-PT).....	68
3.6.1. Specifications .....	69

3.6.2. Hardware interface .....	71
3.6.3. Module parameters .....	73
3.6.4. Mechanical installation .....	75
◆...3.7. 4-channel thermocouple measurement (DF58-M-4TC) .....	77
3.7.1. Specifications .....	78
3.7.2. Hardware interface .....	80
3.7.3. Module parameters .....	82
3.7.4. Mechanical installation .....	85
◆...3.8. 8-channel thermocouple measurement (DF58-M-8TC) .....	86
3.8.1. Specifications .....	87
3.8.2. Hardware interface .....	89
3.8.3. Module parameters .....	92
3.8.4. Mechanical installation .....	96
◆...3.9. Encoder pulse count/24VDC (DF58-M-2CNT-PIL-24) .....	97
3.9.1. Specifications .....	98
3.9.2. Hardware interface .....	99
3.9.3. Module parameters .....	102
3.9.4. Mechanical installation .....	109
◆...3.10. 24V to 5V Power isolation module (DF58-M-DC-U-5) .....	110
3.10.1. Specifications .....	111
3.10.2. Hardware interface .....	112
3.10.3. Mechanical installation .....	115

---

4. The use of examples .....	116
◆...4.1. Sysmac Studio software EtherNet/IP simple instructions .....	116
4.1.1. Communication Connections .....	116
4.1.2. Hardware configuration .....	116
4.1.3. DF58-C-EN-IP configuration byte query .....	117
4.1.4. New Projects .....	119
4.1.5. Add EDS files .....	119
4.1.6. Add global variables .....	121
4.1.7. Add an EIP .....	122
4.1.8. Associated Variables .....	123
4.1.9. Downloads .....	125
4.1.10. Data Monitoring .....	126
5. Appendix I.---- Use of NetModuleSearch Tools .....	134
6. Appendix II.---- Overview of the bytes of the module .....	138

# Preface

## Scope of this document

This document applies to DF58 series remote IO systems

## Introduction

This manual mainly introduces the technical specifications, installation, and debugging of DF58 series remote I/O modules.



Highlights include:

- System Overview: Mainly introduce the product ordering information of DF58 series remote I/O module, product composition, system architecture, product transportation, storage environment, etc.;
- Product Description: Introduce the technical parameters of DF58 series remote I/O module;
- Installation and disassembly guidance: introduce the installation and removal of DF58 series remote I/O modules;
- Mechanical and electrical diagrams: DF58 remote IO module size drawings and electrical wiring diagrams;
- User guide: Introduce the communication between DF58 series remote I/O modules and mainstream PLCs through examples.

## Precautions

This document describes in detail how to use the DF58 series remote I/O modules, and is intended for those with some engineering experience. DEGSON shall not be liable for any consequences arising from the use of this material.

Before attempting to use the equipment, please read the relevant precautions of the equipment carefully, and be sure to follow the safety precautions and operating procedures for installation and commissioning. The degree of harm and damage that may result from the incorrect use of the equipment is illustrated by the symbols below

 <b>DANGER</b>
Imminent risk to life! Notes with the signal word Danger warn you of situations which will result in serious injury or death if you do not follow the instructions given in this manual.
 <b>WARNING</b>
Possible danger to life! Notes with the signal word "Warning" warn you of situations which may result in serious injury or death if you do not follow the instructions given in this manual.
 <b>ATTENTION</b>
Material damage Notes With the signal word "Attention" warn you of hazards which may result in material damage

## Eligibility

This manual provides information on the installation and commissioning of the DF58 series remote I/O modules and is designed for engineers, installers, maintenance personnel, and electricians with a general understanding of automation.

## Recycling and disposal

To ensure that the recycling of your old equipment meets environmental requirements, please contact a certified e-waste disposal facility.

## **Precautions**

If the module is difficult to install, do not use brute force to install, so as not to damage the current module or other modules, disassemble the module from the guide rail, check whether the module is abnormal (such as foreign body blockage, etc.), confirm that there is no problem, and then plug and unplug.



# 1. Product installation and disassembly

## 1.1. Installation

- The DIN rail lock at the bottom of the module can be safely and reliably mounted on a 35 mm DIN rail when the module is installed, and the module needs to be aligned with its notch, push the module towards the DIN bayonet, and place the module on the DIN rail.
- When installing the adapter, there is a manual snap above and on the left side for locking the rails.

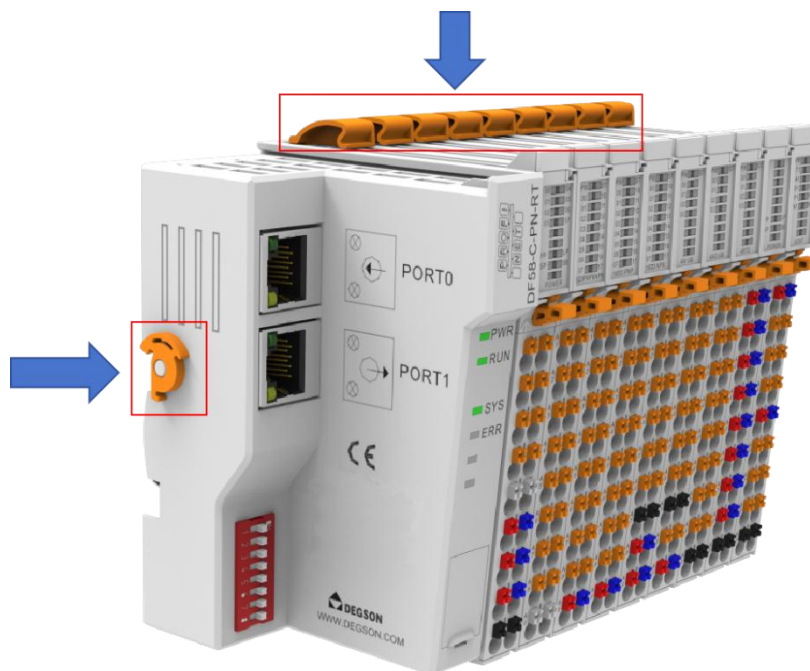

## 1.2. Grounding protection

- There is a metal shrapnel on the back of the module for effective grounding with the guide rail, and the metal shrapnel is connected to the grounding PE of the adapter module.

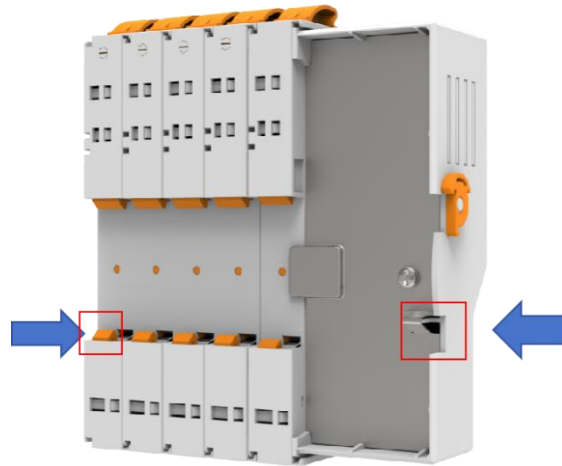

### 1.3. Disassembly method

#### 1.3.1. Module disassembly

First of all, remove all signal or power cables of the module, then press the pins (the yellow part of the arrow above the figure below), and when removing the adapter module, you also need to open the rail lock counterclockwise (the left arrow position).

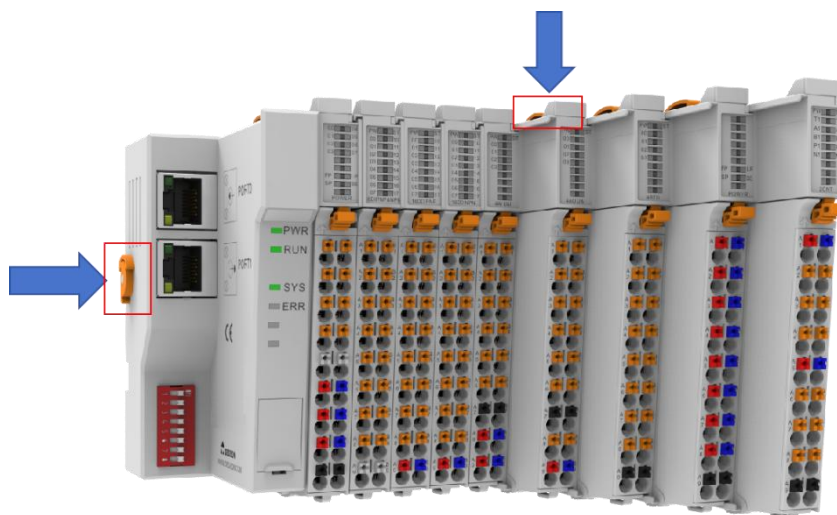

#### 1.3.2. Terminal disassembly

The buckle can be removed separately by pressing the buckle in the direction of the arrow.

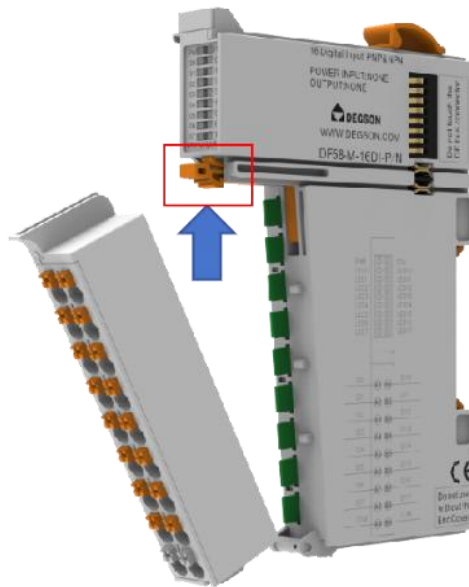

### 1.3.3. Cold-pressed terminals

It is recommended to use cables with a core of less than 1.5 mm<sup>2</sup>, and the parameters of the crimp terminals are as follows

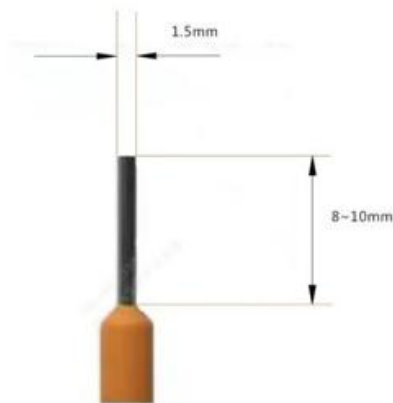

The terminal button is recommended to be used, and it is recommended to use a 0.4\*2.5 screwdriver to press down.

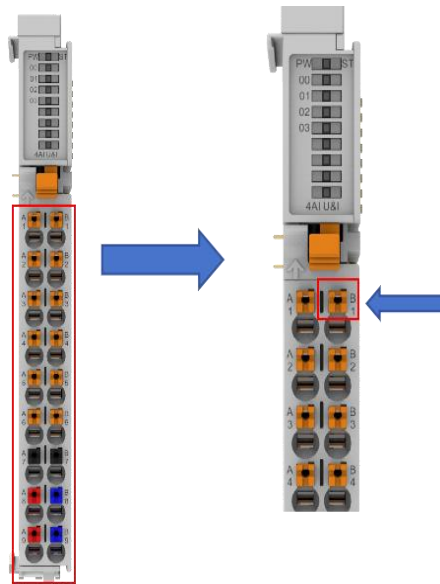

## 1.4. Precautions

- If the module is difficult to install, do not use brute force to install, so as not to damage the current module or other modules, disassemble the module from the guide rail, check whether the module is abnormal (such as foreign body blockage, etc.), confirm that there is no problem, and then plug and unplug.

## 2. Fieldbus adapter

Fieldbus system	description	Model
	EtherNet/IP bus, 2 RJ45, expandable to 32 modules, 24VDC	DF58-C-EN-IP

### 2.1. EtherNet/IP fieldbus adapter (DF58-C-EN-IP).

- The DF58-C-EN-IP fieldbus adapter acts as a slave to connect to EtherNet/IP IO, the open Industrial Ethernet standard in the field of automation. It automatically configures and generates local process images including analog, digital, and special function blocks. Analog modules and special function modules transmit data in the form of words or bytes, while digital modules transmit data in the form of bits.
- The fieldbus adapter can be integrated into the application as an EtherNet/IP IO device.
- It is also equipped with a dual-port switch that makes it easy to create a line structure without using any additional network components.



### 2.1.1. Specifications

Specifications	
name of article	DF58-C-EN-IP
Product Description:	EtherNet/IP bus, 2 RJ45, expandable to 32 modules, 24VDC
Communication protocols	EtherNet/IP
Connection	2 x RJ45 with integrated switch functionality
Transmission rate	10/100Mbps, full duplex
Transmission distance	100 meters
Scalable number of modules	32
Address mapping	Yes
Bus address settings	EtherNet/IP specifications, DIP switches
Transmission medium	Category 5 twisted pair
Isolation method	Electrically isolated from the field layer
Alarm function	Diagnostic alarms, process alarms, plug-in and unplug connector alarms
Minimum cycle time	1ms
Power supply parameters	
The terminal input power supply voltage is rated	24V DC(18V DC~ 28V DC)
The terminal input power supply is rated at current	0.6A
Power protection	Overcurrent protection, anti-reverse polarity protection, surge

Specifications	
	absorption
Connection	PUSH-IN terminal blocks
No-load current	<350mA
Provides internal system voltage	5VDC
Internal system current is supplied	Max.3A
The load voltage is provided	18V... 28VDC
The maximum current of the load is supplied	10A
Mechanical structure	
Ingress protection	IP20
Rail type	35mm DIN
Working environment	
Operating temperature	-25... 60°C
Storage temperature	-40... 85°C
relative humidity	5... 95% RH (non-condensing)
elevation	2000 meters below
Pollution level	Level 2
Immunity	Power cord 2Kv (IEC 61000-4-4)
Overvoltage category	I
EMC anti-interference level	Zone B, IEC61131-2
Vibration resistance	IEC 60068-2-65Hz~8.4Hz, amplitude 3.5 mm, 8.4Hz~150 Hz, acceleration 9.8 m/s <sup>2</sup> , 100 minutes each in X, Y, Z direction (10 times, 10 minutes each time, 100 minutes in total)
Impact resistance	IEC 60068-2-27, 9.8m/s <sup>2</sup> , 11ms, X/Y/Z, 3 times each in 6 directions

## 2.1.2. Hardware interface

### 2.1.2.1. Definition of terminal block

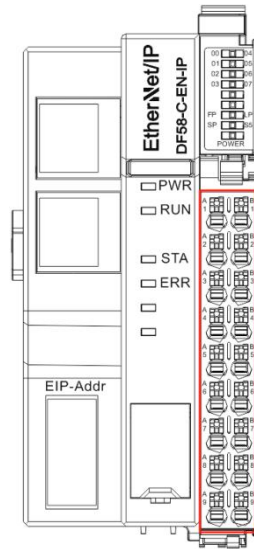

Terminal serial number	Signal	Terminal serial number	Signal	illustrate
A1	DI0	B1	DI4	Digital signal input
A2	DI1	B2	DI5	
A3	DI2	B3	DI6	
A4	DI3	B4	DI7	
A5	COM	B5	COM	DI input on the public side
A6	Field_24V	B6	Field_0V	Load 24V power input
A7	Field_24V	B7	Field_0V	
A8	Sys_24V	B8	Sys_0V	24V power input of the system
A9	PE	B9	PE	Earth

**Note:** It is recommended to use two 24V power supplies isolated from each other to provide two power supplies for each coupler to achieve optimal anti-interference performance.



### 2.1.2.2. LED indicator definition

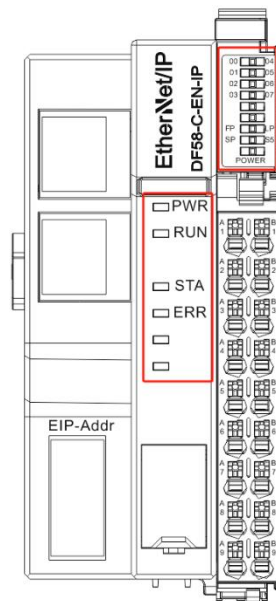

Light	meaning
PWR (green)	Power indicator, PWR indicator lights up when the module is powered normally
RUN (green)	Solid on: The coupler is functioning normally Off: The coupler is operating abnormally Flickering: abnormal configuration;
SYS (green)	On: Communication between the coupler and module is abnormal, Off: The communication between the coupler and module is abnormal
ERR (red)	On: Communication between the coupler and module is abnormal, Off: Normal.
00~07 (green).	Channel input indicator
FP (green)	Green: The load power supply is running normally.
LP (green)	Green: The sensor power supply is operating normally.
SP (green)	Green: The internal system power supply is running normally.
S5 (green)	Green: The internal 5V power supply is running normally.

### 2.1.2.3. Wiring diagram

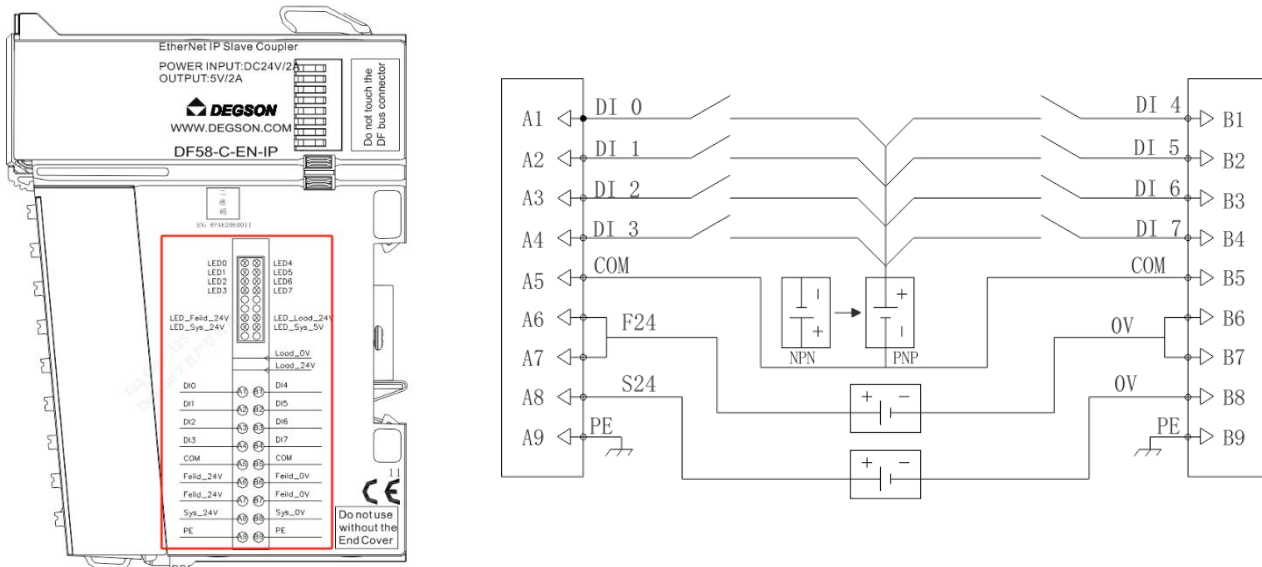

Note: COM is the public side, and the external 24V implements NPN, and the external 0V implements PNP.

### 2.1.2.4. Configure the interface

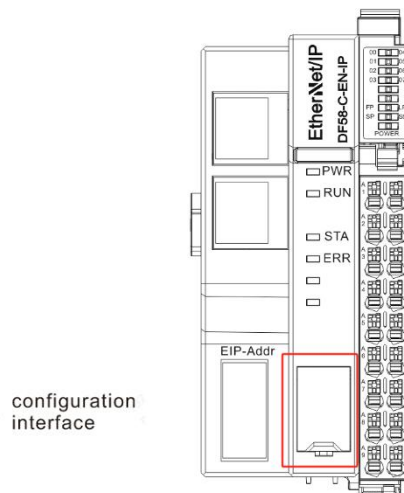

Set the configuration interface to facilitate the program upgrade of the adapter.

**Note:** Non-professionals and authorized personnel are not allowed to use this interface to avoid procedural problems.



**parameters of the login web page.** You need to add 2250 to enter the web page, for example, 192.168.3.100:2250. The default IP address of the web page is 192.168.1.253, and the default username and password are "**admin**", and you can log in to the web page parameter configuration page to configure the parameters. Figure 1 is the login page, Figure 2 is the English page of the module, switch the Chinese and English pages through the Chinese/English button in the upper right corner, and Figure 3 is the Chinese page of the module.

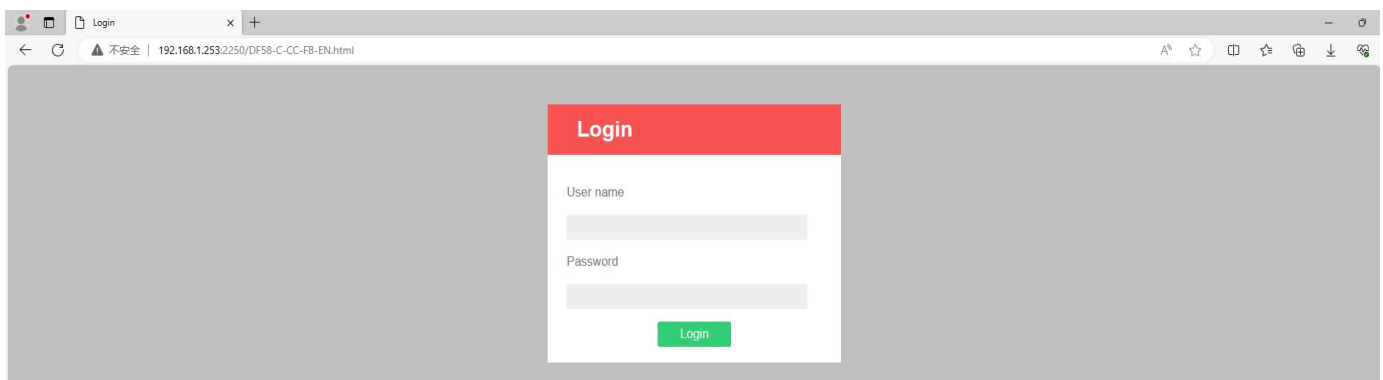

Figure 1 Login page

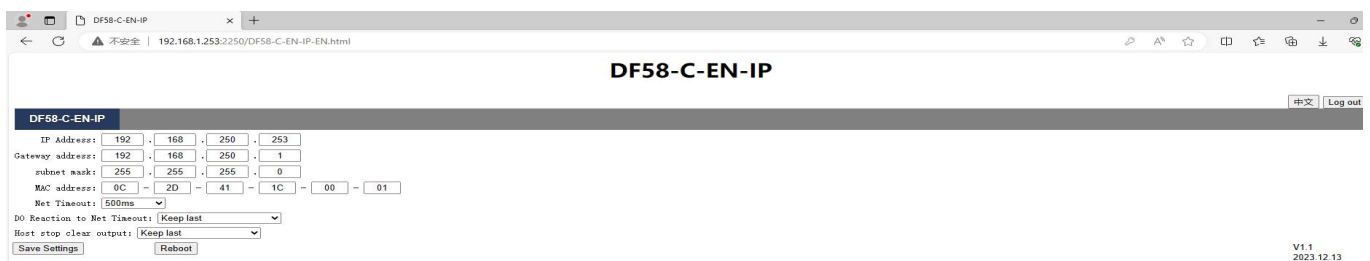

Figure 2 English page

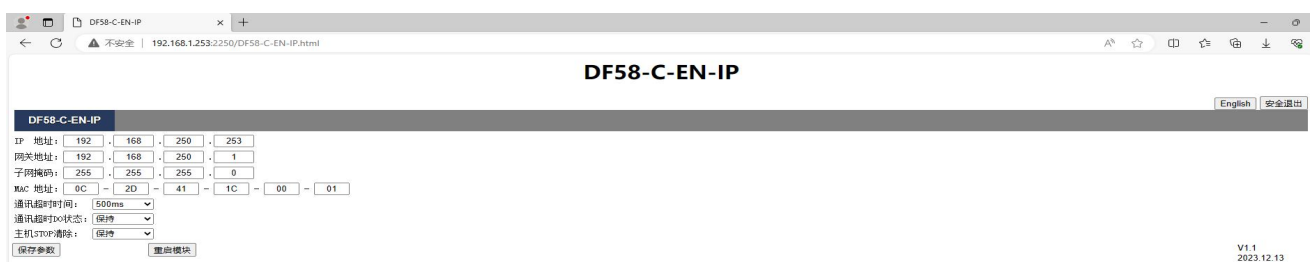

Figure 3 Chinese page

**English/Chinese:** switch between English and Chinese interfaces.

**Log Out:** **Exit** the module's web interface.

**IP address:** To set the coupler to communicate with the connected controller, it must be in the same network segment as the IP address of the controller (192.168.250.253 by default).

**Gateway address:** **Set the** gateway of the coupler (factory default is 192.168.250.1).

**Subnet Mask:** **Set the** mask of the coupler (factory default is 255.255.255.0).

**MAC address:** Set the MAC address of the coupler, if there are multiple devices in the same network, the MAC address cannot be the same, otherwise the communication will be abnormal.

**Communication timeout time:** **After the communication between the coupler** and the controller is disconnected, the output channel of the analog expansion module behind the coupler will be cleared after the corresponding time, with a total of 4 setting items, namely: 200ms, 500ms, 1s, and 3S. When set to 200ms, 500ms, 1s, 3S, the output channel output of the coupler analog expansion module is cleared to zero after the communication is disconnected for more than the set time

**Communication timeout DO state:** **After the communication between the coupler and the** controller is disconnected, the output channel output of the digital expansion module behind the coupler is cleared or maintained, with a total of 3 setting items, namely: hold, clear output, and turn on output.

**STOP clearing:** When the host changes from RUN to STOP, the execution action setting of the digital output and analog output module channels behind the coupler (**Note: only some hosts support this function, such as KEYENCE PLC**).

**Yes:** When the host changes from RUN to STOP, the channel output of the digital output and analog output module after the coupler is cleared to zero

**Not:**When the host changes from RUN to STOP, the channel output of the digital output and analog output module after the coupler is maintained;

### 2.1.4.2. DIP parameters

DIP switch	illustrate
	<p>When all DIPs are set to OFF, configure the IP address used by the coupler for EIP communication through the web page, and set the range XXX.XXX.XXX.1~XXX.XXX.XXX.254. The "XXX.XXX.XXX." indicates the CIDR block to which it is connected in actual use.</p> <p>When the DIP switch is dialed to ON, the last digit of the IP address used by the coupler for EIP communication is the value set by the DIP switch, and the network segment is subject to the web page setting, for example, the IP address is set on the web page 192.168.250.123, and the DIP switch 1 and 2 are dialed to ON, and the others are OFF, and the IP address of the coupler is 192.168.250.3.</p> $IP = SW1 \times 20 + SW2 \times 21 + \dots + SW8 \times 27$ <p>Concentrate:</p> <p>(1) The maximum range of addresses can be set to XXX.XXX.XXX.1 ~ XXX.XXX.XXX.254</p> <p>(2) The dial code sets the IP address, and it will only take effect when the module is powered off and restarted.</p>

### 2.1.4.3. Network port description

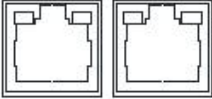
Ethernet port	illustrate
	<p>It is used for EtherNet/IP communication and has switch function.</p>

### 2.1.4.4. Module parameters

For example, define the DI address as Input1: Byte (defined based on actual requirements, for reference only).

Type/Total Bytes	region	Number of bytes occupied (The number of bytes in the corresponding area is sorted in descending order)	illustrate
INPUT/1BYTE	INPUT AREA/1BYTE	1Byte	Digital I0.0~I0.7 input address

### 3. Expand the I/O module

function	description	Model
Digital modules	Digital inputs, 16 inputs, PNP/NPN	DF58-M-16DI-P/N
Digital modules	Digital output, 16 output, PNP	DF58-M-16DO-P
Digital modules	Digital outputs, 16 outputs, NPN	DF58-M-16DO-N
Digital modules	Analog input, 4 channels, voltage and current type	DF58-M-4AI-UI-6
Analog Module	Analog output, 4 channels, voltage and current type	DF58-M-4AO-UI-6
Temperature module	RTD measurement, 4 channels	DF58-M-4RTD-PT
Temperature module	Thermocouple measurement, 4 channels	DF58-M-4TC
Temperature module	Thermocouple measurement, 8 channels	DF58-M-8TC
Pulse Counting Module	Encoder input/pulse output, 2 channels	DF58-M-2CNT-PIL-24
Voltage distribution module	Voltage distribution/24VDC to 5VDC	DF58-M-DC-U-5





### 3.1.1. Specifications

Specifications	
Model	DF58-M-16DI-P/N
Product Description:	Digital input module, 16 inputs, NPN+PNP, 24VDC
Signal type	NPN & PNP
"ON" signal voltage	>15V DC
"OFF" signal voltage	<5V DC
Hardware response time	100us/100us
Number of channels	16
Data size	2 Byte
Connection type	1-wire system, according to IEC 61131-2
Reverse circuit protection	Yes
Isolation method	Photoelectric isolation from the field layer
Error diagnosis	Yes
Signal (0) Input current per channel (typical)	0.678mA
Signal (1) Input current of each channel (typical)	4.07mA
Signal (1) The minimum input current of each channel	2.46mA
Signal (1) The maximum input current of each channel	4.7mA
Filtering time	No filtering, 0.25ms, 0.5ms, 1ms (factory setting), 2ms, 4ms, 8ms, 16ms, 32ms, you can set 2 groups of filtering parameters, a group of 8 channels, and a common filtering parameter within the group
Input impedance	5.6kΩ
Input action display	When the input is in the driving state, the input indicator lights up (the LED is controlled by the IO software of the microcontroller)
Enter the derating	Derating 75% at 55°C (no more than 12 ON input points at the same time) or 10°C at ON input points
IO mapping	Supports bit-by-bit access, byte-by-byte access, and word-by-word access
Power supply parameters	
Operating voltage	24V DC +20%/ -15%
System feed current	<15mA
Mechanical structure	
Ingress protection	IP20
Rail type	35mm DIN

Environmental requirements	
Operating temperature	-25... 60°C
Storage temperature	-40... 85°C
relative humidity	5... 95% RH (non-condensing)
Pollution level	2. Comply with IEC 61131-2 standard
Working altitude	0 ... 2000 m
Vibration-resistant	4g, according to IEC 60068-2-6
Impact-resistant	15g, IEC 60068-2-27
EMC - Interference immunity	Complies with EN 61000-6-2
EMC - Radiated Interference	Complies with EN 61000-6-3
Corrosion resistance	IEC 60068-2-42 and IEC 60068-2-43 compliant
Permissible H <sub>2</sub> S pollutant concentration at 75 % relative humidity	10ppm
Permissible SO <sub>2</sub> pollutant concentration at 75 % relative humidity	25ppm
Firmware upgrades	Yes

### 3.1.2. Hardware interface

#### 3.1.2.1. Definition of terminal block

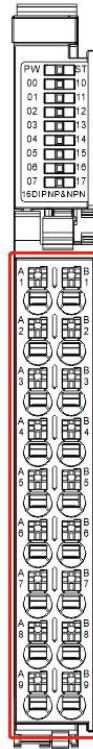

Terminal serial number	Signal	Terminal serial number	Signal	illustrate
A1	DI 0	B1	DI 10	DI signal input
A2	DI 1	B2	DI 11	
A3	DI 2	B3	DI 12	
A4	DI 3	B4	DI 13	
A5	DI 4	B5	DI 14	
A6	DI 5	B6	DI 15	
A7	DI 6	B7	DI 16	
A8	DI 7	B8	DI 17	
A9	COM	B9	COM	The DI signal is input to the common end

### 3.1.2.2. LED indicator definition

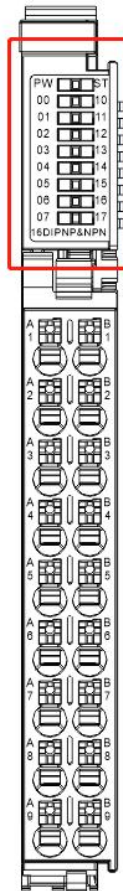

Light	meaning
PW (green)	Bright: The internal bus power supply is normal Off: The internal bus power supply is abnormal
STA (red)	Backplane bus communication fault alarm indication: Solid on: Bus communication failure Off: Normal.
00~07(Green)	Input indication of channels DI0~DI7.
10~17(Green)	Input indication of channels DI10~DI17.

### 3.1.2.3. Wiring diagram

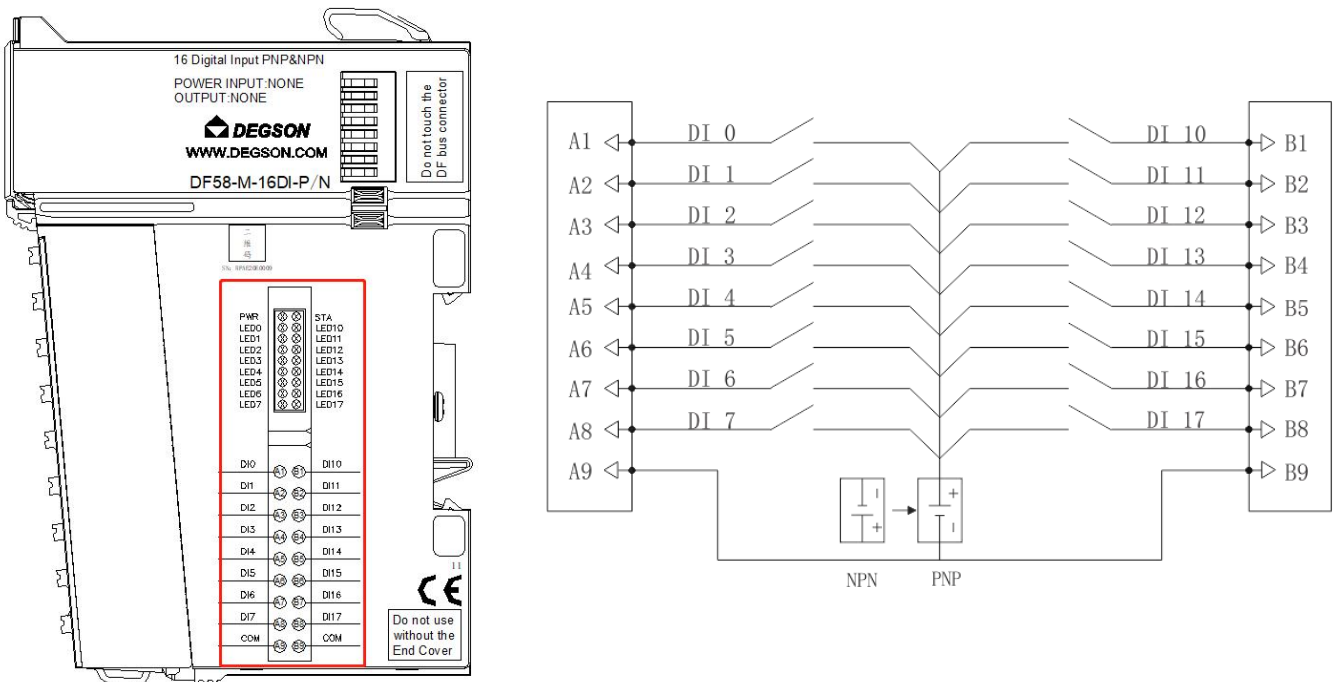

Note: COM is the public side, which is connected to 24V to implement NPN, and external 0V to implement PNP.

### 3.1.3. Module parameters

Overview of the number of bytes of the module

The name of the module	Enter the number of bytes	Number of bytes output
DF58-M-16DI	4	2

#### 3.1.3.1. Input Parameter Definition

The input address consists of the input area + diagnostic information area, which is shown in the following table:

Type/Total Bytes	region	Number of bytes occupied (The number of bytes in the corresponding area is sorted in descending order)	illustrate
INPUT/4BYTE	INPUT/2BYTE	1 Byte	Digital I0.0~I0.7 input address
		2Byte	Digital I1.0~I1.7 input address
	DIAGNOSTIC INFORMATION AREA/2BYTE	3Byte	1: Bus fault; 0: The bus is normal;
		4Byte	reserve

### 3.1.3.2. Output parameter definition

The output address consists of an output area + a parameter configuration area, which is shown in the following table:

Type/Total Bytes	region	Number of bytes occupied (The number of bytes in the corresponding area is sorted in descending order)	illustrate
OUTPUT/2BYTE	PARAMETER CONFIGURATION AREA/2 BYTES	1Byte	Set the filtering parameters of channels 1~8: 0: No filter (default); 1: 0.25ms; 2: 0.5ms; 3: 1ms; 4: 2ms; 5: 4ms; 6: 8ms; 7: 16ms; 8: 32ms;
		2Byte	Set the filtering parameters of channels 9~16:

			0: No filter (default); 1: 0.25ms; 2: 0.5ms; 3: 1ms; 4: 2ms; 5: 4ms; 6: 8ms; 7: 16ms; 8: 32ms;
--	--	--	--

### 3.1.4. Mechanical installation

#### 3.1.4.1. Installation dimensions

The installation size information is shown in the figure below, and the unit is (mm).

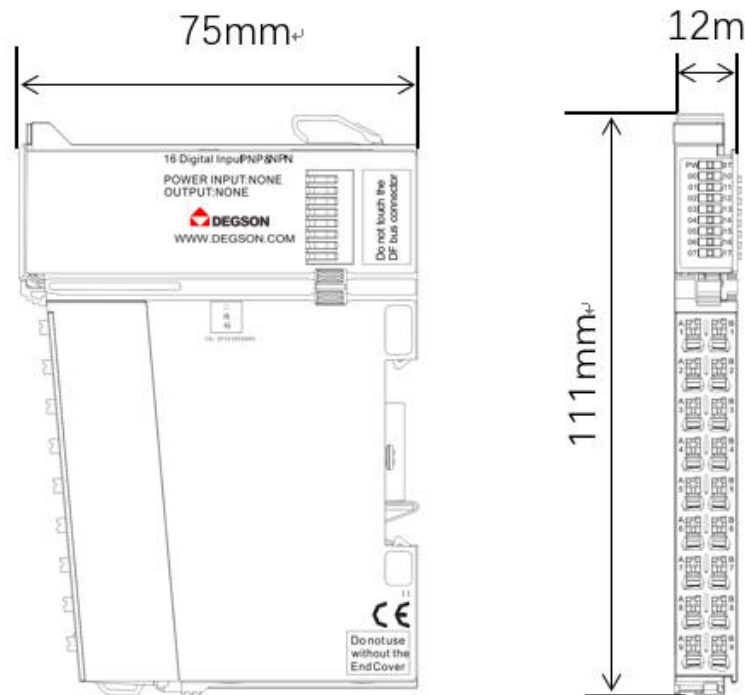



### 3.2. 16-channel digital output/24VDC/PNP (DF58-M-16DO-P).

- The digital output module transmits the binary signal of the automation equipment to the connected actuator (solenoid valve, etc.).
- 16 channels of digital output, PNP active high.
- Each output module is equipped with an anti-interference filter.
- Each output module has an LED indicator.
- The field level and the system level are isolated by optocouplers.
- IP20 degree of protection.

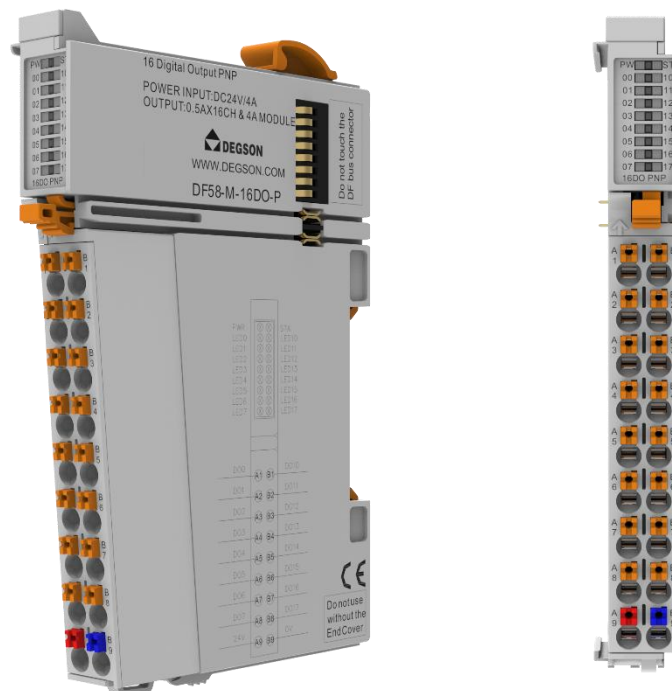

### 3.2.1. Specifications

Specifications	
Model	DF58-M-16DO-P
Product Description:	Digital output module, 16 outputs, PNP, 24VDC
Signal type	PNP
"OFF" signal voltage	High impedance state
"ON" signal voltage	24V DC
Number of channels	16
Data size	2 Byte
Connection type	1-wire system
Reverse circuit protection	Yes
Overcurrent protection	Yes
Short-circuit protection	Yes
Isolation method	Photoelectric isolation from the field layer
Error diagnosis	Yes
Switching Frequency (Resistive)	100Hz
Switching Frequency (Lamp)	10Hz
Switching Frequency (Inductive)	0.2Hz
The response time of the protection circuit	<180us
The maximum output current per channel	500 mA
Leakage current	Maximum: 10uA
Hardware response time	100us/100us
Output impedance	<200mΩ
Output delay	OFF to ON :Max.100us , ON to OFF :Max.150us
Protection features	Overcurrent protection: Typical value 1.9A
The type of load	Inductive (7.2W/dot, 24W/module), Resistive (0.5A/dot, 4A/module), Lamp (5W/dot, 18W/module)
The output action is displayed	When the output is in the driving state, the indicator light is on (the LED is controlled by the IO software of the microcontroller)
Enter the derating	Derate by 50% at 55°C (while the output current of ON does not exceed 2A), or 10°C at full ON at the output point
IO mapping	Supports bit-by-bit access, byte-by-byte access, and word-by-word access

Fault shutdown output state mode	Clear to zero, keep the current value, and output according to the preset value
Fault shutdown output preset	0 or 1
Shutdown mode	Output according to the fault shutdown state mode and preset value, no longer refreshed
<b>Power supply parameters</b>	
Operating voltage	24V DC +20%/ -15%
System feed current	<75mA
<b>Mechanical structure</b>	
Ingress protection	IP20
Rail type	35mm DIN
<b>Environmental requirements</b>	
Operating temperature	-25... 60°C
Storage temperature	-40... 85°C
relative humidity	5... 95% RH (non-condensing)
Pollution level	2. Comply with IEC 61131-2 standard
Working altitude	0 ... 2000 m
Vibration-resistant	4g, according to IEC 60068-2-6
Impact-resistant	15g, IEC 60068-2-27
EMC - Interference immunity	Complies with EN 61000-6-2
EMC - Radiated Interference	Complies with EN 61000-6-3
Corrosion resistance	IEC 60068-2-42 and IEC 60068-2-43 compliant
Permissible H <sub>2</sub> S pollutant concentration at 75 % relative humidity	10ppm
Permissible SO <sub>2</sub> pollutant concentration at 75 % relative humidity	25ppm
Firmware upgrades	Yes

### 3.2.2. Hardware interface

#### 3.2.2.1. Definition of terminal block

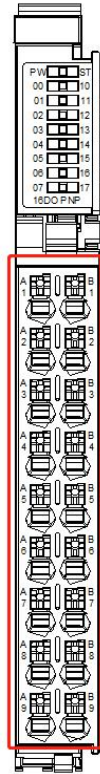

Pin ordinal	signal	Pin ordinal	signal	illustrate
A1	DO 0	B1	DO 10	DO signal output
A2	DO 1	B2	DO 11	
A3	DO 2	B3	DO 12	
A4	DO 3	B4	DO 13	
A5	DO 4	B5	DO 14	
A6	DO 5	B6	DO 15	
A7	DO 6	B7	DO 16	
A8	DO 7	B8	DO 17	
A9	24V	B9	0V	24V power input of the module

### 3.2.2.2. LED indicator definition

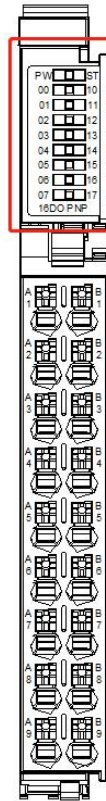

Light	meaning
PW (green)	Bright: The internal bus power supply is normal Off: The internal bus power supply is abnormal
STA (red)	Backplane bus communication fault alarm indication: Solid on: Bus communication failure Off: Normal.
00~07(Green)	Channel DO0~DO7 output indicator.
10~17(Green)	Channel DO10~DO17 output indicator.

### 3.2.2.3. Wiring diagram

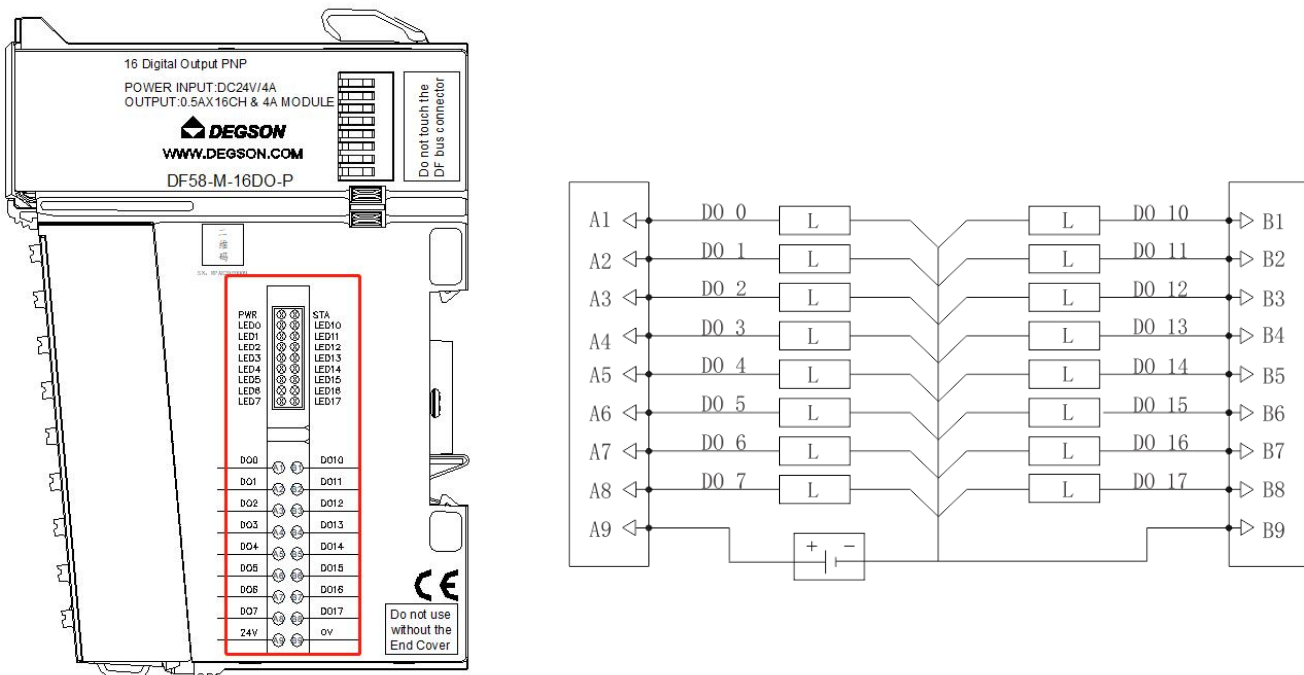

Note: A9 and B9 are connected to 0V power supply and are provided externally.

### 3.2.3. Module parameters

Overview of the number of bytes of the module

The name of the module	Enter the number of bytes	Number of bytes output
DF58-M-16DO-P	2	3

#### 3.2.3.1. DF58-M-16DO-P input parameter definition

The input address consists of the input area + diagnostic information area, which is shown in the following table

Type/Total Bytes	region	Number of bytes occupied (The number of bytes in the corresponding area is sorted in descending order)	illustrate

Type/Total Bytes	region	Number of bytes occupied (The number of bytes in the corresponding area is sorted in descending order)	illustrate
INPUT/2BYTE	DIAGNOSTIC INFORMATION AREA/2BYTE	1BYTE	Bit0: 1: Bus fault; 0: The bus is normal; Bit1: 1: Channel 24V is not connected; 0: channel 24V access; Bit2: 1: Channel 1~8 any channel is short-circuited; 0: The channel is normal Bit3: 1: Channel 9~16 any channel is short-circuited; 0: The channel is normal Bit4~Bit7: Reserved
		2BYTE	reserve

### 3.2.3.2. DF58-M-16DO-P output parameter definition

The output address consists of the output area + parameter configuration area, as shown in the following table

Type/Total Bytes	region	Number of bytes occupied (The number of bytes in the corresponding area is sorted in descending order)	illustrate
OUTPUT/3BYTE	OUTPUT AREA/2BYTE	1byte	Byte0:Q0.0~Q0.7
		2byte	Byte1:Q1.0~Q1.7
	PARAMETER CONFIGURATION AREA/1 BYTE	3byte	Disconnection output function setting 0: The output remains in the state before disconnection 1: The output is cleared 2: All channels are output

### 3.2.4. Mechanical installation

#### 3.2.4.1. Installation dimensions

The installation size information is shown in the figure below, and the unit is (mm).

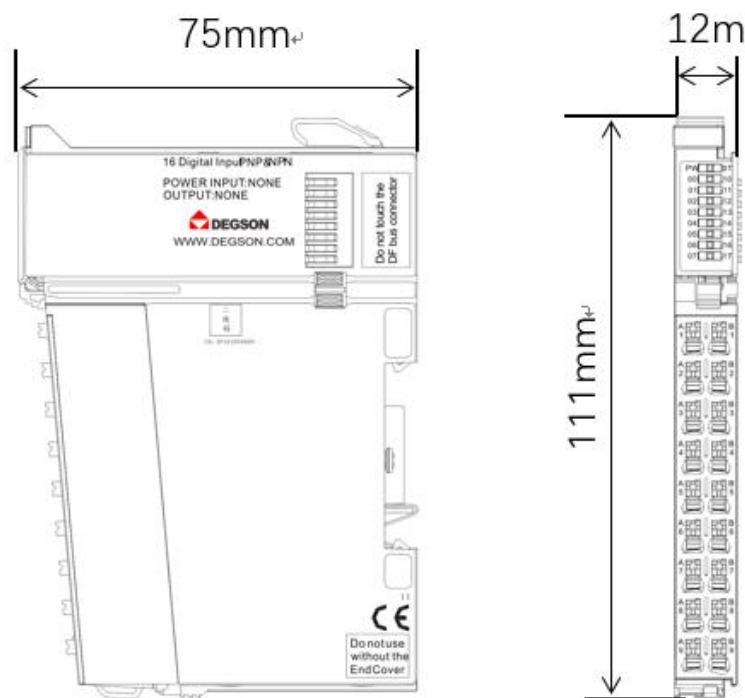



### 3.3. 16-channel digital output/24VDC/NPN(DF5-M-16DO-N)

- The digital output module transmits the binary signal of the automation equipment to the connected actuator (solenoid valve, etc.).
- 16 channels of digital output, NPN active-low.
- Each output module is equipped with an anti-interference filter.
- Each output module has an LED indicator.
- The field level and the system level are isolated by optocouplers.
- IP20 degree of protection.



### 3.3.1. Specifications

Specifications	
Model	DF58-M-16DO-N
Product Description:	Digital output module, 16 outputs, NPN, 24VDC
Signal type	NPN
"OFF" signal voltage	High impedance state
"ON" signal voltage	0V DC
Number of channels	16
Data size	2 Byte
Connection type	1-wire system
Reverse circuit protection	Yes
Overcurrent protection	Yes
Short-circuit protection	Yes
Isolation method	Photoelectric isolation from the field layer
Error diagnosis	Yes
Switching Frequency (Resistive)	100Hz
Switching Frequency (Lamp)	10Hz
Switching Frequency (Inductive)	0.2Hz
The response time of the protection circuit	< 180μs
The maximum output current per channel	500 mA
Leakage current	Maximum: 10uA
Hardware response time	100us/100us
Output impedance	<200mΩ
Output delay	OFF to ON :Max.100us , ON to OFF :Max.150us
Protection features	Overcurrent protection: Typical value 1.9A
The type of load	Inductive (7.2W/dot, 24W/module), Resistive (0.5A/dot, 4A/module), Lamp (5W/dot, 18W/module)
The output action is displayed	When the output is in the driving state, the indicator light is on (the LED is controlled by the IO software of the microcontroller)
Enter the derating	Derate by 50% at 55°C (while the output current of ON does not exceed 2A), or 10°C at full ON at the output point
IO mapping	Supports bit-by-bit access, byte-by-byte access, and word-by-word access

Fault shutdown output state mode	Clear to zero, keep the current value, and output according to the preset value
Fault shutdown output preset	0 or 1
Shutdown mode	Output according to the fault shutdown state mode and preset value, no longer refreshed
<b>Power supply parameters</b>	
Operating voltage	24V DC +20%/ -15%
System feed current	<75mA
<b>Mechanical structure</b>	
Ingress protection	IP20
Rail type	35mm DIN
<b>Environmental requirements</b>	
Operating temperature	-25... 60°C
Storage temperature	-40... 85°C
relative humidity	5... 95% RH (non-condensing)
Pollution level	2. Comply with IEC 61131-2 standard
Working altitude	0 ... 2000 m
Vibration-resistant	4g, according to IEC 60068-2-6
Impact-resistant	15g, IEC 60068-2-27
EMC - Interference immunity	Complies with EN 61000-6-2
EMC - Radiated Interference	Complies with EN 61000-6-3
Corrosion resistance	IEC 60068-2-42 and IEC 60068-2-43 compliant
Permissible H <sub>2</sub> S pollutant concentration at 75 % relative humidity	10ppm
Permissible SO <sub>2</sub> pollutant concentration at 75 % relative humidity	25ppm
Firmware upgrades	Yes

### 3.3.2. Hardware interface

#### 3.3.2.1. Definition of terminal block

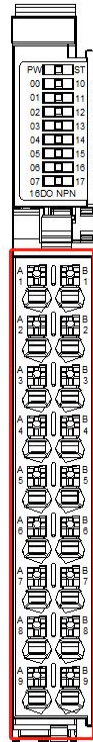

Pin ordinal	signal	Pin ordinal	signal	illustrate
A1	DO 0	B1	DO 10	DO signal output
A2	DO 1	B2	DO 11	
A3	DO 2	B3	DO 12	
A4	DO 3	B4	DO 13	
A5	DO 4	B5	DO 14	
A6	DO 5	B6	DO 15	
A7	DO 6	B7	DO 16	
A8	DO 7	B8	DO 17	
A9	24V	B9	0V	24V power input of the module

### 3.3.2.2. LED indicator definition

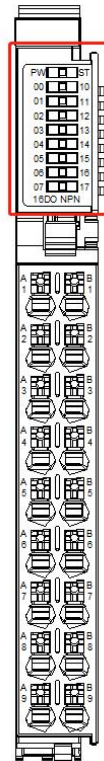

Light	meaning
PW (green)	Bright: The internal bus power supply is normal Off: The internal bus power supply is abnormal
STA (red)	Backplane bus communication fault alarm indication: Solid on: Bus communication failure Off: Normal.
00~07(Green)	Channel DO0~DO7 output indicator.
10~17(Green)	Channel DO10~DO17 output indicator.

### 3.3.2.3. Wiring diagram

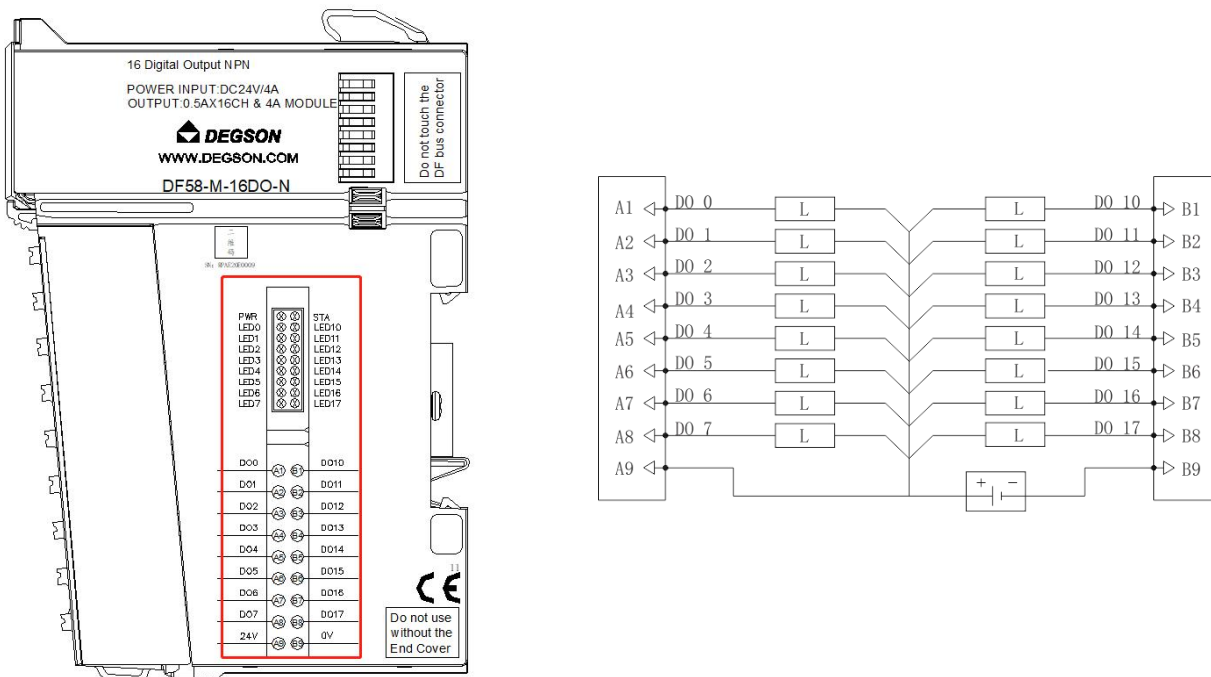

Note: A9 and B9 are connected to 24V power supply and are provided externally.

### 3.3.3. Module parameters

Overview of the number of bytes of the module

The name of the module	Enter the number of bytes	Number of bytes output
DF58-M-16DO-N	2	3

#### 3.3.3.1. DF58-M-16DO-N input parameter definition

The input address consists of the input area + diagnostic information area, which is shown in the following table

Type/Total Bytes	region	Number of bytes occupied (The number of bytes in the corresponding area is sorted in descending order)	illustrate
INPUT/2BYTE	DIAGNOSTIC INFORMATION AREA/2BYTE	1BYTE	Bit0: 1: Bus fault, 0: Bus normal; Bit1: 1: Channel 24V is not connected; 0: channel 24V access; Bit2: 1: Channel 1~4 any channel is short-circuited; 0: The channel is normal. Bit3: 1: Channel 5~8 any channel short circuit; 0: The channel is normal. Bit4: 1: Channel 9~12 is short-circuited 0: The channel is normal. Bit5: 1: Channel 13~16 is short-circuited 0: The channel is normal. Bit6~Bit7: Reserved
		2BYTE	reserve

### 3.3.3.2. DF58-M-16DO-N output parameter definition

The output address consists of the output area + parameter configuration area, as shown in the following table

Type/Total Bytes	region	Number of bytes occupied (The number of bytes in the corresponding area is sorted in descending order)	illustrate

Type/Total Bytes	region	Number of bytes occupied (The number of bytes in the corresponding area is sorted in descending order)	illustrate
OUTPUT/3BYTE	OUTPUT AREA/2BYTE	1byte	Digital Q0.0~Q0.7 output address
		2byte	Digital Q1.0~Q1.7 output address
	PARAMETER CONFIGURATION AREA/1 BYTE	3byte	The output status of the module when the connection is disconnected 0: The output remains in the state before disconnection 1: The output is cleared 2: All channels are output

### 3.3.4. Mechanical installation

#### 3.3.4.1. Installation dimensions

The installation size information is shown in the figure below, and the unit is (mm).

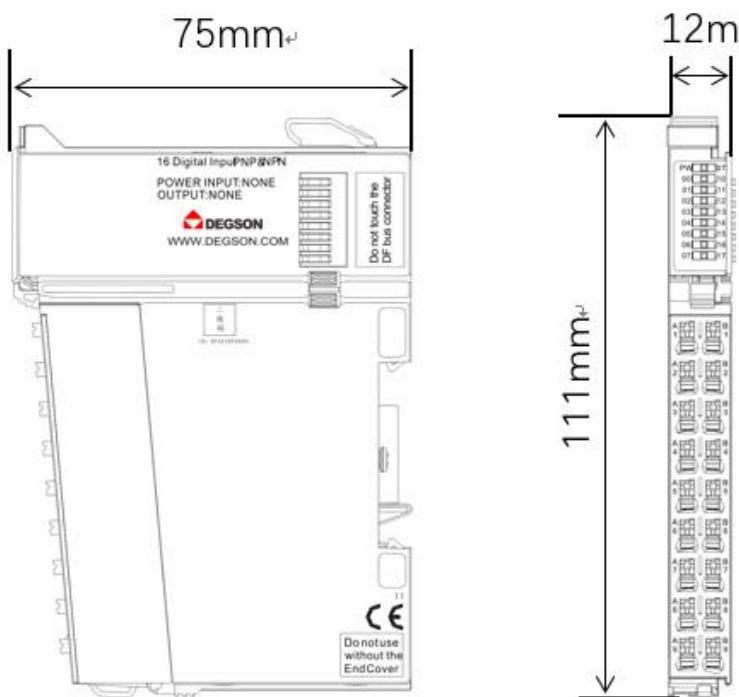



### 3.4. 4-channel analog input/voltage/current (DF58-M-4AI-UI-6).

- The analog input module receives voltage, current, and standard signals.
- 4-channel analog input, voltage type, current type.
- The two LED indicators indicate that the module is operating normally and the communication is normal, respectively.
- Magnetic isolation between the field layer and the system layer.
- Transmitted in 16-bit resolution.
- IP20 degree of protection

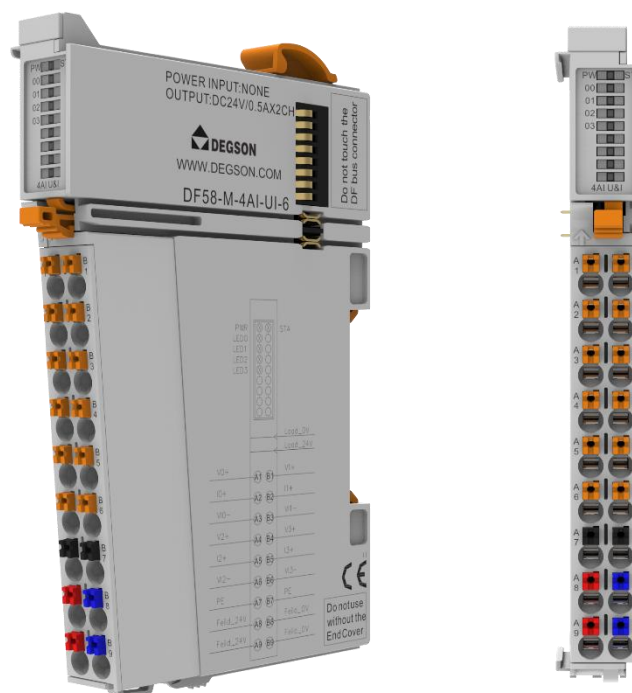

### 3.4.1. Specifications

Specifications	
Model	DF58-M-4AI-UI-6
Product Description:	Analog input module, 4 inputs, voltage type, current type
Input method	Voltage type, current type
Number of channels	4
Conversion time	400us/channel
Voltage input range	$\pm 10V$ 、0-10V、2-10V、 $\pm 5V$ 、0-5V、1-5V
Voltage input impedance	$> 100K\Omega$
Voltage input accuracy (25°C)	$\pm 0.1\%$ (full scale)
Voltage input accuracy (over full temperature range)	$\pm 0.2\%$ (full scale)
Voltage input limit	$\pm 15V$
Voltage input diagnostics	Yes
Current input range	$\pm 20mA$ 、0-20mA、4-20mA
Current acquisition impedance	250 $\Omega$
Current Input Accuracy (25°C)	$\pm 0.1\%$ (full scale)
Current Input Accuracy (Full Temperature Range)	$\pm 0.2\%$ (full scale)
Current input limit	Instantaneous $\pm 30mA$ , average $\pm 24mA$
Current input diagnostics	Disconnection detection is not supported
Whether or not to quarantine	There is no isolation between interface channels, the power supply is isolated from the interface, and the interface is isolated from the bus
Configure the diagnostic escalation function	Support input upper and lower overflow alarm diagnosis and reporting
Conversion mode configuration	$\pm 10V$ , 0-10V, 2-10V, $\pm 5V$ , 0-5V, 1-5V, $\pm 20mA$ , 0-20mA, 4-20mA
Filter parameter configuration	The software filtering time can be configured by the host computer, and the setting range is 0-65535, and the unit is the sampling period
Enable overrun detection	Yes
Peak Hold Enable configuration	Yes
Convert digital range configurations	The default configuration $\pm 32000$
Sampling time	4 channels 4ms
Sample refresh	Asynchronous refresh according to the sampling time, and synchronous refresh by bus cycle is not required
Stop mode	Keeps the current value and does not refresh again

Signal type	difference
Data size	8 Byte
resolution	16 Bit
<b>Power supply parameters</b>	
Operating voltage	24V DC +20%/ -15%
System feed current	<120mA
<b>Mechanical structure</b>	
Ingress protection	IP20
Rail type	35mm DIN
<b>Environmental requirements</b>	
Operating temperature	-25... 60°C
Storage temperature	-40... 85°C
relative humidity	5... 95% RH (non-condensing)
Pollution level	2. Comply with IEC 61131-2 standard
Working altitude	0 ... 2000 m
Vibration-resistant	4g, according to IEC 60068-2-6
Impact-resistant	15g, IEC 60068-2-27
EMC - Interference immunity	Complies with EN 61000-6-2
EMC - Radiated Interference	Complies with EN 61000-6-3
Corrosion resistance	IEC 60068-2-42 and IEC 60068-2-43 compliant
Permissible H <sub>2</sub> S pollutant concentration at 75 % relative humidity	10ppm
Permissible SO <sub>2</sub> pollutant concentration at 75 % relative humidity	25ppm
Firmware upgrades	Yes

### 3.4.2. Hardware interface

#### 3.4.2.1. Definition of terminal block

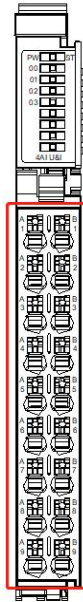

Terminal serial number	Signal	Terminal serial number	Signal	illustrate
A1	V0+	B1	V1+	Positive side of the voltage input channel
A2	I0+	B2	I1+	Current input channel positive
A3	V0-/I0-	B3	V1-/I1-	Negative terminal of voltage/current input
A4	V2+	B4	V3+	Positive side of the voltage input channel
A5	I2+	B5	I3+	Current input channel positive
A6	V2-/I2-	B6	V3-/I3-	Negative terminal of voltage/current input
A7	PE	B7	PE	earth
A8	Load 24V	B8	Load 0V	24V power output
A9	Load 24V	B9	Load 0V	24V power output

### 3.4.2.2. LED indicator definition

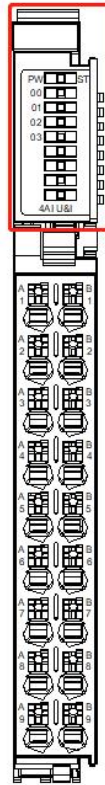

Light	meaning
PW (green)	Bright: The internal bus power supply is normal Off: The internal bus power supply is abnormal
STA (red)	Backplane bus communication fault alarm indication: Solid on: Bus communication failure Off: Normal.
LED0~LED3	No effect

### 3.4.2.3. Wiring diagram

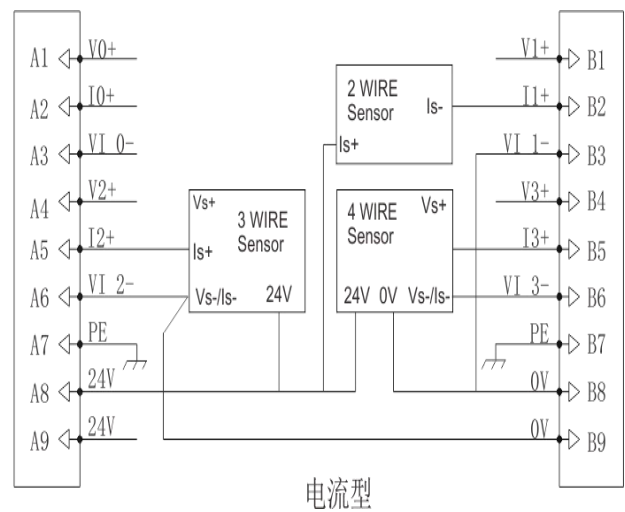
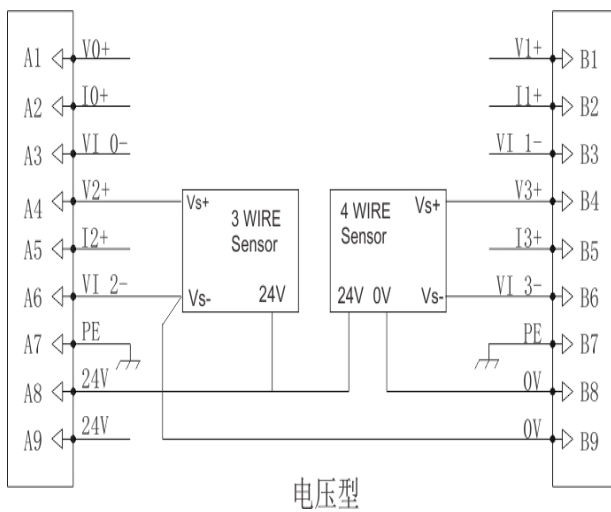
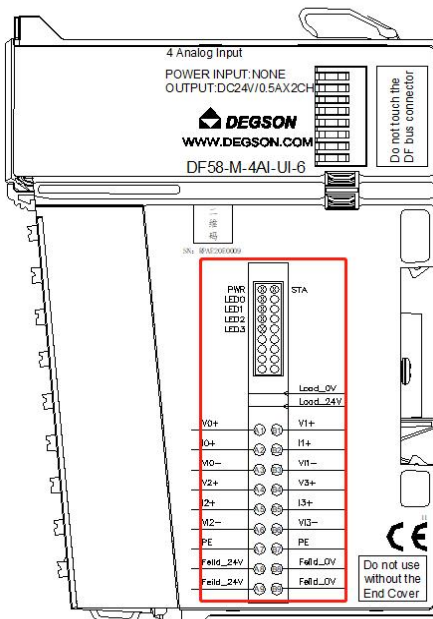

### 3.4.3. Module parameters

Overview of the number of bytes of the module

The name of the module	Enter the number of bytes	Number of bytes output
DF58-M-4AI-UI-6	10	5

### 3.4.3.1. Input Parameter Definition

The input address consists of the input area + diagnostic information area, which is shown in the following table

Type/Total Bytes	region	Number of bytes occupied (The number of bytes in the corresponding area is sorted in descending order)	illustrate
INPUT/10BYTE	INPUT AREA/8BYTE	THE 1~2BYTE	Channel 1 enters the address
		THE 3~4BYTE	Enter the address in channel 2
		THE 5TH~6BYTE	Enter the address for channel 3
		THE 7~8BYTE	Enter the address in channel 4
	DIAGNOSTIC INFORMATION AREA/2BYTE	9BYTE	Bit0: 1: Bus fault, 0: Bus normal. Bit1: Reserved Bit2: 1: Overflow on channel 1, 0: normal. Bit3: 1: Overflow under channel 1, 0: normal. Bit4: 1: Overflow on channel 2, 0: Normal. Bit5: 1: Overflow under channel 2;0: Normal. Bit6: 1: Overflow on channel 3;0: Normal. Bit7: 1: Overflow under channel 3;0: Normal.
		10BYTE	Bit0:

			1: Overflow on channel 4, 0: Normal. Bit1: 1: Overflow under channel 4;0: Normal. Bit2~Bit7: Reserved.
--	--	--	---

### 3.4.3.2. Output parameter definition

The output address consists of the output area + parameter configuration area, as shown in the following table

Type/Total Bytes	region	Number of bytes occupied (The number of bytes in the corresponding area is sorted in descending order)	illustrate
OUTPUT AREA/5BYTE	PARAMETER CONFIGURATION AREA/5 BYTES	The 1st ~ 2nd byte	Reserved.
		3rd byte	reserve
		4th byte	Set the input channel 1~2 range: 0:-10~10VDC; 1:0~10VDC; 2:2~10VDC; 3:-5~5VDC; 4:0~5VDC; 5:1~5VDC; 6:-20~20mA; 7:0~20mA; 8:4~20mA;
		5th byte	Set the input channel 3~4 range: 0:-10~10VDC; 1:0~10VDC; 2:2~10VDC; 3:-5~5VDC; 4:0~5VDC; 5:1~5VDC;



			6:-20~20mA; 7:0~20mA; 8:4~20mA;
--	--	--	---------------------------------------

### 3.4.4. Mechanical installation

#### 3.4.4.1. Installation dimensions

The installation size information is shown in the figure below, and the unit is (mm).

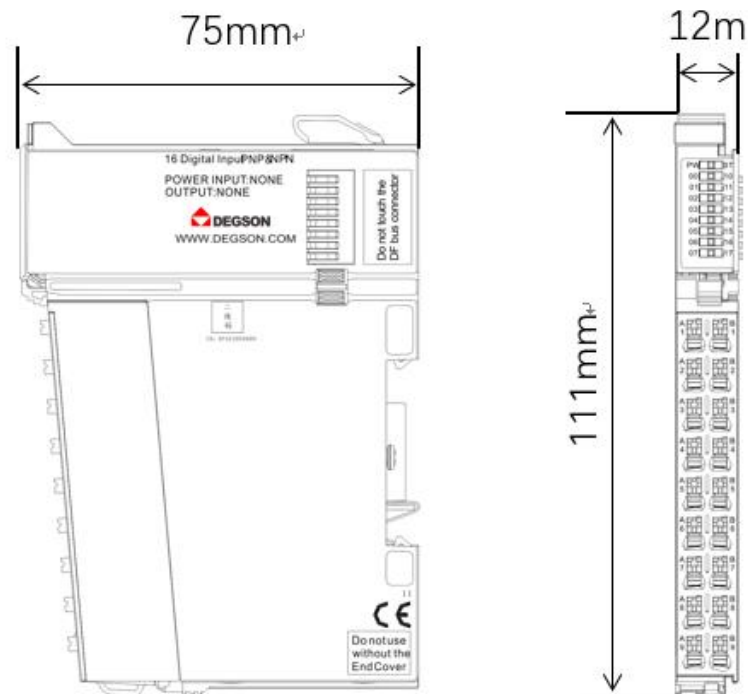

### 3.5. 4-channel analogue output/voltage/current (DF58-M-4AO-UI-6).

- The analog output module receives output voltage and current standard signals.
- 4-channel analog output, voltage and current type.
- The two LED indicators indicate that the module is operating normally and the communication is normal, respectively.
- Magnetic isolation between the field layer and the system layer.
- Transmitted in 16 resolutions.
- IP20 degree of protection.

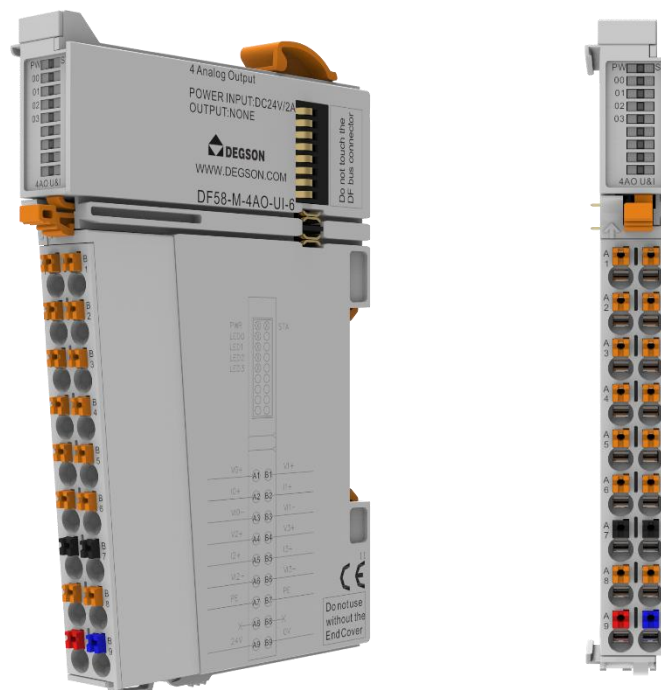

### 3.5.1. Specifications

Specifications	
Model	DF58-M-4AO-UI-6
type	Analog output
Measuring range	Voltage, current
Number of channels	4
resolution	16 Bit
Conversion time	3ms/channel
Voltage output range	±10V、0-10V、2-10V、±5V、0-5V、1-5V
Voltage output load	1KΩ
Voltage output accuracy (25°C)	±0.1% (full scale)
Voltage output accuracy (over full temperature range)	±0.5% (full scale)
Current output range	±20mA、0-20mA、4-20mA
Current output load	0-600Ω
Current Output Accuracy (25°C)	±0.1% (full scale)
Current Output Accuracy (Full Temperature Range)	±0.5% (full scale)
Whether or not to quarantine	There is no isolation between interface channels, the power supply is isolated from the interface, and the interface is isolated from the bus
Configure the diagnostic escalation function	Yes
Conversion mode configuration	±10V, 0-10V, 2-10V, ±5V, 0-5V, 1-5V, 0-20mA, 4-20mA
Output status configuration after shutdown	Clear, keep current output, output preset value
Output preset value configuration after shutdown	Yes
Convert digital range configurations	Fixed range ± 32000
Stop mode	Output according to the fault shutdown state mode and preset value, no longer refreshed
Signal type	difference
Data size	8 Byte
Error diagnosis	YES
The type of load	Sensual, resistive, capacitive
Protection current	20mA
Temperature coefficient	<20 ppm

Power supply parameters	
Operating voltage	24V DC +20%/ -15%
System feed current	<110mA
Mechanical structure	
Ingress protection	IP20
Rail type	35mm DIN
Environmental requirements	
Operating temperature	-25... 60°C
Storage temperature	-40... 85°C
relative humidity	5... 95% RH (non-condensing)
Pollution level	2. Comply with IEC 61131-2 standard
Working altitude	0 ... 2000 m
Vibration-resistant	4g, according to IEC 60068-2-6
Impact-resistant	15g, IEC 60068-2-27
EMC - Interference immunity	Complies with EN 61000-6-2
EMC - Radiated Interference	Complies with EN 61000-6-3
Corrosion resistance	IEC 60068-2-42 and IEC 60068-2-43 compliant
Permissible H2S pollutant concentration at 75 % relative humidity	10ppm
Permissible SO2 pollutant concentration at 75 % relative humidity	25ppm
Firmware upgrades	Yes

### 3.5.2. Hardware interface

#### 3.5.2.1. Definition of terminal block

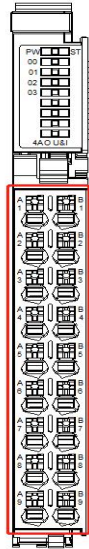

Terminal serial number	Signal	Terminal serial number	Signal	illustrate
A1	V0+	B1	V1+	The positive pole of the voltage output channel
A2	I0+	B2	I1+	The current output channel is positive
A3	V0-/I0-	B3	V1-/I1-	Negative terminal at voltage/current output
A4	V2+	B4	V3+	The positive pole of the voltage output channel
A5	I2+	B5	I3+	The current output channel is positive
A6	V2-/I2-	B6	V3-/I3-	Negative terminal of voltage/current input
A7	PE	B7	PE	earth
A8	\	B8	\	\
A9	Load 24V	B9	Load 0V	24V power input of the module

### 3.5.2.2. LED indicator definition

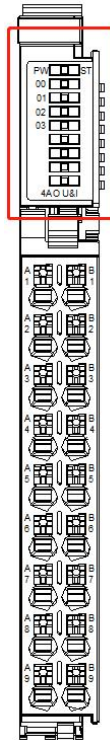

Light	meaning
PW (green)	Bright: The internal bus power supply is normal Off: The internal bus power supply is abnormal
STA (red)	Backplane bus communication fault alarm indication: Solid on: Bus communication failure Off: Normal.

### 3.5.2.3. Wiring diagram

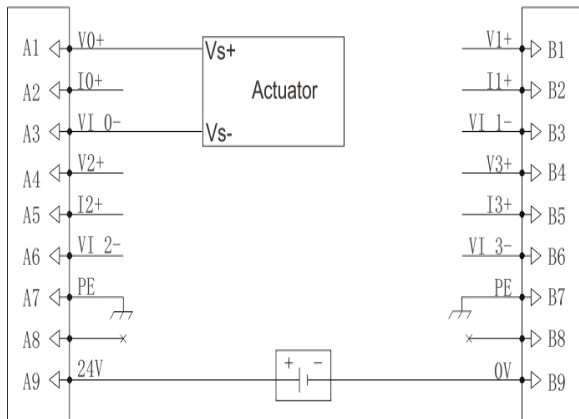
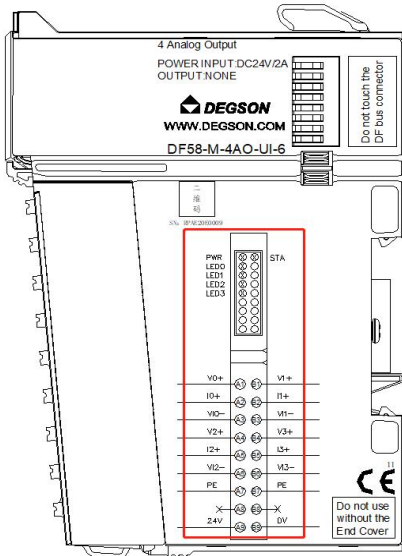

电压型

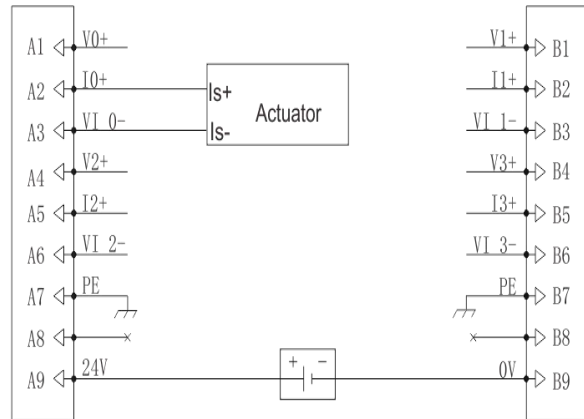

电流型

### 3.5.3. Module parameters

Overview of the number of bytes of the module

The name of the module	Enter the number of bytes	Number of bytes output
DF58-M-4AO-UI-6	2	17

### 3.5.3.1. Input Parameter Definition

The input address consists of the input area + diagnostic information area, which is shown in the following table

Type/Total Bytes	region	Number of bytes occupied (The number of bytes in the corresponding area is sorted in descending order)	illustrate
INPUT/2BYTE	DIAGNOSTIC INFORMATION AREA/2BYTE	1st BYTE	Bit0: 1: Bus fault; 0: The bus is normal; Bit1: 1: Channel 24V is not connected; 0: channel 24V access; Bit3~Bit7: Reserved
		2nd BYTE	reserve

### 3.5.3.2. Output parameter definition

The output address consists of the output area + parameter configuration area, as shown in the following table

**Pay special attention to the DF58-M-4AO-UI-6 channel 1~4 default 0 configuration (output disabled), please configure the channel before using it.**

Type/Total Bytes	region	Number of bytes occupied (The number of bytes in the corresponding area is sorted in descending	illustrate
------------------	--------	--	------------



		order)	
OUTPUT/17BYTE	Output area/8byte	The 1st ~ 2nd byte	Channel 1 output address
		The 3rd ~ 4th byte	Channel 2 output address
		The 5th ~ 6th byte	Channel 3 output address
		7~8 bytes	Channel 4 output address
	Parameter configuration area/9 bytes	9th byte	reserve
		10th byte	Module output when disconnected: 0: The channel output is cleared 1: The channel output remains in the state before the disconnection. 2: The channel output preset
		The 11th ~ 12th bytes	Set the output preset
		13th byte	Channel 1 sets the range: 0:DISABLE (default); 1:0~5VDC;      2:1~5VDC; 3:-5~5VDC;     4:0~10VDC; 5:2~10VDC;    6:-10~10VDC; 7:0~20mA;     8:4~20mA;
		14th byte	Channel 2 sets the range: 0:DISABLE (default); 1:0~5VDC;      2:1~5VDC; 3:-5~5VDC;     4:0~10VDC; 5:2~10VDC;    6:-10~10VDC; 7:0~20mA;     8:4~20mA;
		15th byte	Channel 2 sets the range: 0:DISABLE (default); 1:0~5VDC;      2:1~5VDC; 3:-5~5VDC;     4:0~10VDC; 5:2~10VDC;    6:-10~10VDC; 7:0~20mA;     8:4~20mA;
		16th byte	Channel 4 sets the range: 0:DISABLE (default); 1:0~5VDC;      2:1~5VDC; 3:-5~5VDC;     4:0~10VDC; 5:2~10VDC;    6:-10~10VDC; 7:0~20mA;     8:4~20mA;

---

		17th byte	reserve
--	--	-----------	---------

### 3.5.4. Mechanical installation

#### 3.5.4.1. Installation dimensions

The installation size information is shown in the figure below, and the unit is (mm).

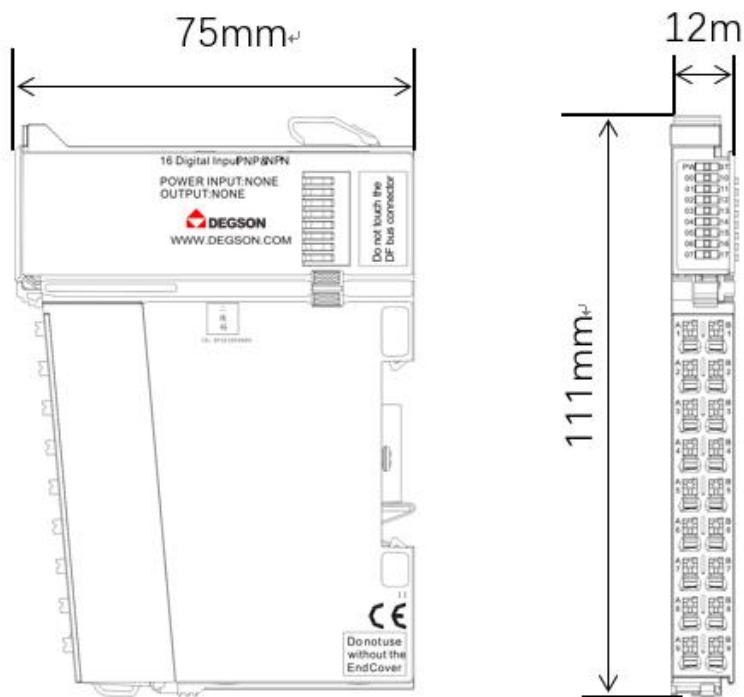

### 3.6. 4-channel RTD measurement (DF58-M-4RTD-PT).

- The module uses 4-channel RTD measurement and supports 13 conventional RTDs.
- Quad sensor support
- Support 2-wire, 3-wire, 4-wire sensors.
- The two LED indicators indicate that the module is operating normally and the communication is normal, respectively.
- Each channel has an LED indicator.
- Magnetic isolation between the field layer and the system layer.
- Transmitted in 16 resolutions.
- IP20 degree of protection.



### 3.6.1. Specifications

Technical Information	
Model	DF58-M-4RTD-PT
Product Description:	RTD measurement module, 16-bit resolution, 4 channels
Measuring range	RTD
Number of channels	4
Signal type	Pt100, Pt200, Pt500, Pt1000, Ni100, Ni120, Ni 200, Ni500, Ni1000, Cu10.40 Ω, 80 Ω, 150 Ω, 300 Ω, 500 Ω, 1kΩ, 2kΩ, 4kΩ
Temperature range	depending on the sensor type 0.1mA (Pt100, Ni100, Ni120, Cu10, 40 Ω, 80 Ω, 150 Ω, 300 Ω) or 0.1mA (Pt200, Pt500, Pt1000, Ni200, Ni500, Ni1000, 500 Ω, 1kΩ, 2kΩ, 4kΩ)
precision	max. 0.2 % FSR / 0.3 % FSR for Ni sensors / 0.6 % FSR for Cu10
Sensor current	depending on the sensor type 0.1mA (Pt100, Ni100, Ni120, Cu10, 40 Ω, 80 Ω, 150 Ω, 300 Ω) or 0.1mA (Pt200, Pt500, Pt1000, Ni200, Ni500, Ni1000, 500 Ω, 1kΩ, 2kΩ, 4kΩ)
Connection type	2/3/4 wire
Temperature coefficient	±50 ppm/K max.
Reverse polarity protection	Yes
Module diagnostics	Yes
Single-channel diagnostics	Yes
Isolation method	Each channel is magnetically isolated from the field layer and isolated between channels
Data size	8 Byte
Internal resistance	>500KΩ
resolution	16bit, 0.1 °C/per digit
diagnosis	Disconnection / Parameter assignment error
Process alarms	Upper/lower limit per channel
Conversion time	2s/4 channels
Power supply parameters	
Operating voltage	24V DC +20%/ -15%
System feed current	<110mA
Wiring parameters	
Connection technology: input/output	PUSH-IN terminal blocks
Connection type	Inputs/Outputs
The crimping area of the wire	0.2~1.5mm <sup>2</sup> /26~16AWG
Strip length	8 ~ 10mm
Installation:	DIN-35 type guide rail

Material parameters	
color	light gray
Housing material	PC plastic, PA66
Flag of Conformance	THAT
Environmental requirements	
Allowable ambient temperature (at runtime).	-25 ~ 60°C
Allowable ambient temperature (storage).	-40 ~ 85°C
Protection type	IP20
Pollution level	2. Comply with IEC 61131-2 standard
Working altitude	Temperature without derating: 0~2000m
Installation location	arbitrarily
Relative humidity (non-condensing).	5~95%RH
Vibration-resistant	4g, according to IEC 60068-2-6
Impact-resistant	15g according to IEC 60068-2-27
EMC—Immunity to interference	Complies with EN 61000-6-2
EMC—Radiated Interference	Complies with EN 61000-6-3
Corrosion resistance	IEC 60068-2-42 and IEC 60068-2-43 compliant
Permissible H <sub>2</sub> S pollutant concentration at 75 % relative humidity	10ppm
Permissible SO <sub>2</sub> pollutant concentration at 75 % relative humidity	25ppm

### 3.6.2. Hardware interface

#### 3.6.2.1. Definition of terminal block

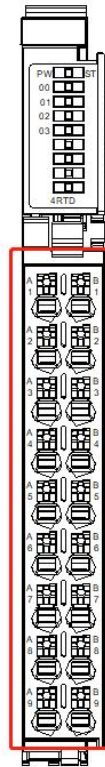

Terminal serial number	Signal	Terminal serial number	Signal	illustrate
A1	RTD0+	B1	RTD0-	RTD signal input channel 1
A2	Sense0+	B2	Sense0-	
A3	RTD1+	B3	RTD1-	RTD signal input channel 2
A4	Sense1+	B4	Sense1-	
A5	RTD2+	B5	RTD2-	RTD signal input channel 3
A6	Sense2+	B6	Sense2-	
A7	RTD3+	B7	RTD3-	RTD signal input channel 4
A8	Sense3+	B8	Sense3-	
A9	PE	B9	PE	earth

### 3.6.2.2. LED indicator definition

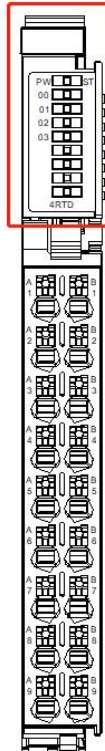

Light	meaning
PW (green)	Bright: The internal bus power supply is normal Off: The internal bus power supply is abnormal
STA (red)	Backplane bus communication fault alarm indication: Solid on: Bus communication failure Off: Normal.
00 (green)	Channel 1 Indicator: Flashing: Normal sampling, Solid: Exceeding upper and lower limits: Extinguished: disconnected;
01 (green)	Channel 2 Indicator: Flashing: Normal sampling, Solid: Exceeding upper and lower limits: Extinguished: disconnected;
02 (green)	Channel 3 Indicator: Flashing: Normal sampling, Solid: Exceeding upper and lower limits: Extinguished: disconnected;
03 (green)	Channel 4 Indicator: Flashing: Normal sampling, Solid: Exceeding upper and lower limits: Extinguished: disconnected;



### 3.6.2.3. Wiring diagram

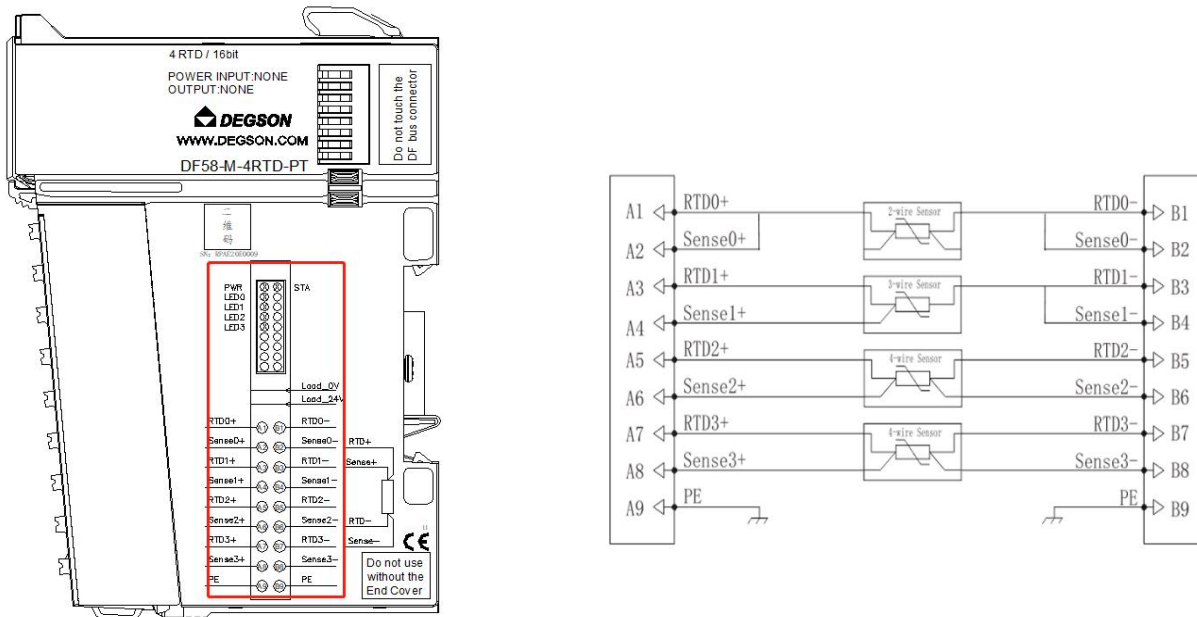

Remark:

The excitation power + and signal + of the RTD sensor **are usually two red wires, which** do not distinguish functions and can be mixed

**The excitation power supply-, signal--is usually two blue wires, or 1 blue and 1 black, which can be mixed without distinguishing functions;**

### 3.6.3. Module parameters

The name of the module	Enter the number of bytes	Number of bytes output
DF58-M-4RTD-PT	10	3

### 3.6.3.1. Input Parameter Definition

The input address consists of the input area + diagnostic information area, which is shown in the following table

Type/Total Bytes	region	Number of bytes occupied (The number of bytes in the corresponding area is sorted in descending order)	illustrate
INPUT/10BYTE	INPUT AREA/8BYTE	THE 1~2BYTE	Channel 1 enters the address
		THE 3~4BYTE	Enter the address in channel 2
		THE 5TH~6BYTE	Enter the address for channel 3
		THE 7~8BYTE	Enter the address in channel 4
	DIAGNOSTIC INFORMATION AREA/2BYTE	THE 9BYTE	Bit0: 1: Bus fault 0: The bus is normal Bit1: 1: Channel 1 is disconnected or exceeds the upper and lower limits 0: Normal Bit2: 1: Channel 2 is disconnected or exceeds the upper and lower limits 0: Normal Bit3: 1: Channel 3 is disconnected or exceeds the upper and lower limits 0: Normal Bit4: 1: Channel 4 is disconnected or exceeds the upper and lower limits

			0: Normal Bit5~Bit7: Reserved
		THE 10BYTE	reserve

### 3.6.3.2. Output parameter definition

The output address consists of the output area + parameter configuration area, as shown in the following table

Type/Total Bytes	region	Number of bytes occupied (The number of bytes in the corresponding area is sorted in descending order)	illustrate
OUTPUT/3BYTE	PARAMETER CONFIGURATION AREA/3 BYTES	2Byte	Reserved
		1byte	Configure 4 channel input types: 0:Pt100; 1:Pt200; 2:Pt500; 3:Pt1000; 4:Ni100; 5:Ni120; 6:Ni200; 7:Ni500; 8:Ni1000; 9:Cu10; 10:40Ω; 11:80Ω; 12:150Ω; 13:300Ω; 14:500Ω; 15:1kΩ; 16:2kΩ; 17: 4kΩ

### 3.6.4. Mechanical installation

#### 3.6.4.1. Installation dimensions

The installation size information is shown in the figure below, and the unit is (mm).

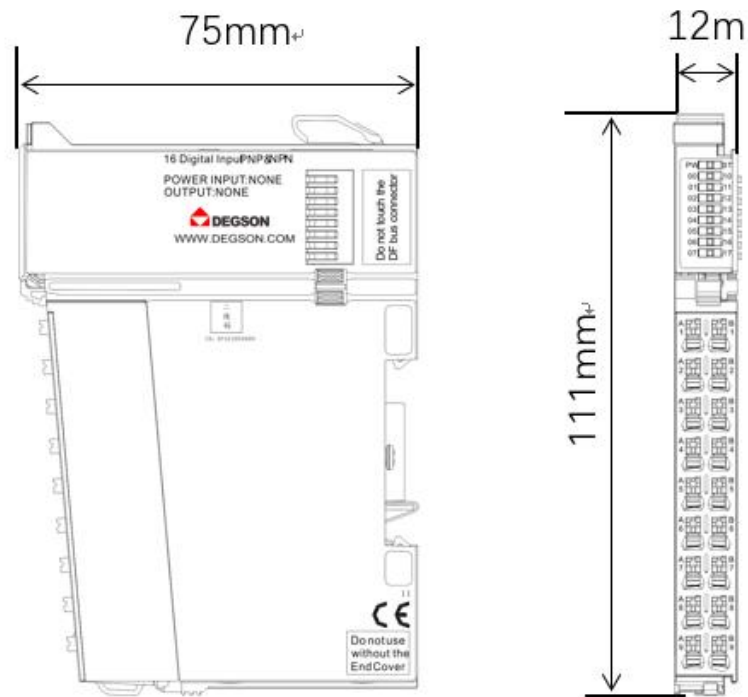

### 3.7. 4-channel thermocouple measurement (DF58-M-4TC)

- The module uses 4-channel thermocouple measurements and supports K/E/T/J/B/S/R/N/L types.
- Supports 2/3/4 wire sensors.
- The two LED indicators indicate that the module is operating normally and the communication is normal, respectively.
- Each channel has an LED indicator.
- Magnetic isolation between the field layer and the system layer.
- Transmitted in 16 resolutions.
- IP20 degree of protection.



### 3.7.1. Specifications

Specifications		
Model	DF58-M-4TC	
Product Description:	Thermocouple module, 4 inputs, 16-bit resolution	
Measuring range	thermocouple	
Number of channels	4	
Signal type	E(-200 ~ 1000°C),S(-50 ~ 1,768°C),J(-210 ~ 1,200°C) T(-200~400°C),K(-200~1.372°C) N(-200 ~ 1300°C), R(-50 ~ 1,768°C) ±15.625mV、±31.25mV、±62.5mV、±125mV、±250mV、±500mV、 ±1V	
Internal resistance	1 MΩ	
Cold junction compensation	Supports internal and external NTC compensation	
Module diagnostics	be	
Temperature coefficient	≤ 50 ppm/K	
Connection type	2-wire system	
Reverse polarity protection	Yes	
Isolation method	Magnetically isolated from the field layer	
Data size	8 Byte	
Error diagnosis	YES	
Single module diagnostics	YES	
Internal resistance	>500KΩ	
resolution	16bit, 0.1 °C/per digit	
Margin of error	Operational errors	±0.5%
	Fundamental error	±0.5% @ 25°C
	Temperature error	±0.005%/K
	Linearity error	±0.05%/K
	The repeatability is in steady state	±0.05%/K
Data size	2 Byte	
Measuring range	-32768~32767	
precision	±0.2% FSR / 0.3% FSR for nickel sensors / 0.6% FSR for Cu10	
Power supply parameters		
Connection	PUSH-IN terminal blocks	
Operating voltage	24V DC +20%/ -15%	
System feed current	<100mA	
The maximum crimping area of	1.5mm <sup>2</sup>	

the wire	
Maximum crimping area of conductor (AWG)	AWG16
The minimum crimping area of the wire	0.14mm <sup>2</sup>
Minimum crimp area (AWG) of conductor	AWG26
Dial length	8...9mm
The maximum crimping area of the wire	1.5mm <sup>2</sup>
<b>Mechanical structure</b>	
Ingress protection	IP20
Rail type	35mm DIN
<b>Working environment</b>	
Operating temperature	-25... 60°C
Storage temperature	-40... 85°C
relative humidity	5... 95% RH (non-condensing)

## 3.7.2. Hardware interface

### 3.7.2.1. Definition of terminal block

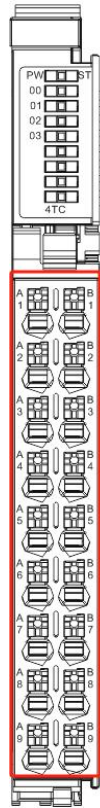

Terminal serial number	Signal	Terminal serial number	Signal	illustrate
A1	TC0+	B1	TC0-	Channel 0 thermocouple terminals
A2	CJC0+	B2	CJC0-	Channel 0 external NTC compensation terminal
A3	TC1+	B3	TC1-	Channel 1 thermocouple terminals
A4	CJC1+	B4	CJC1-	Channel 1 external NTC compensation terminal
A5	TC2+	B5	TC2-	Channel 2 thermocouple terminals
A6	CJC2+	B6	CJC2-	Channel 2 external NTC compensation terminal
A7	TC3+	B7	TC3-	Channel 3 thermocouple terminals
A8	CJC3+	B8	CJC3-	Channel 3 external NTC



				compensation terminal
A9	PE	B9	PE	earth

### 3.7.2.2. LED indicator definition

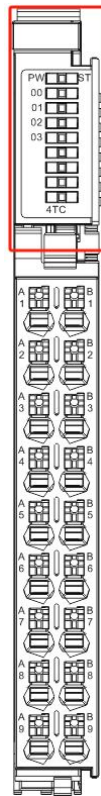

Light	meaning
PW (green)	Bright: The internal bus power supply is normal Off: The internal bus power supply is abnormal
STA (red)	Backplane bus communication fault alarm indication: Solid on: Bus communication failure Off: Normal.
00 (green)	Channel 1 Indicator: Flashing: Normal sampling, Solid: Exceeding upper and lower limits: Extinguished: disconnected;
01 (green)	Channel 2 Indicator: Flashing: Normal sampling, Solid: Exceeding upper and lower limits: Extinguished: disconnected;
02 (green)	Channel 3 Indicator: Flashing: Normal sampling, Solid: Exceeding upper and lower limits: Extinguished: disconnected;
03 (green)	Channel 4 Indicator: Flashing: Normal sampling, Solid: Exceeding upper and lower limits: Extinguished: disconnected;

### 3.7.2.3. Wiring diagram

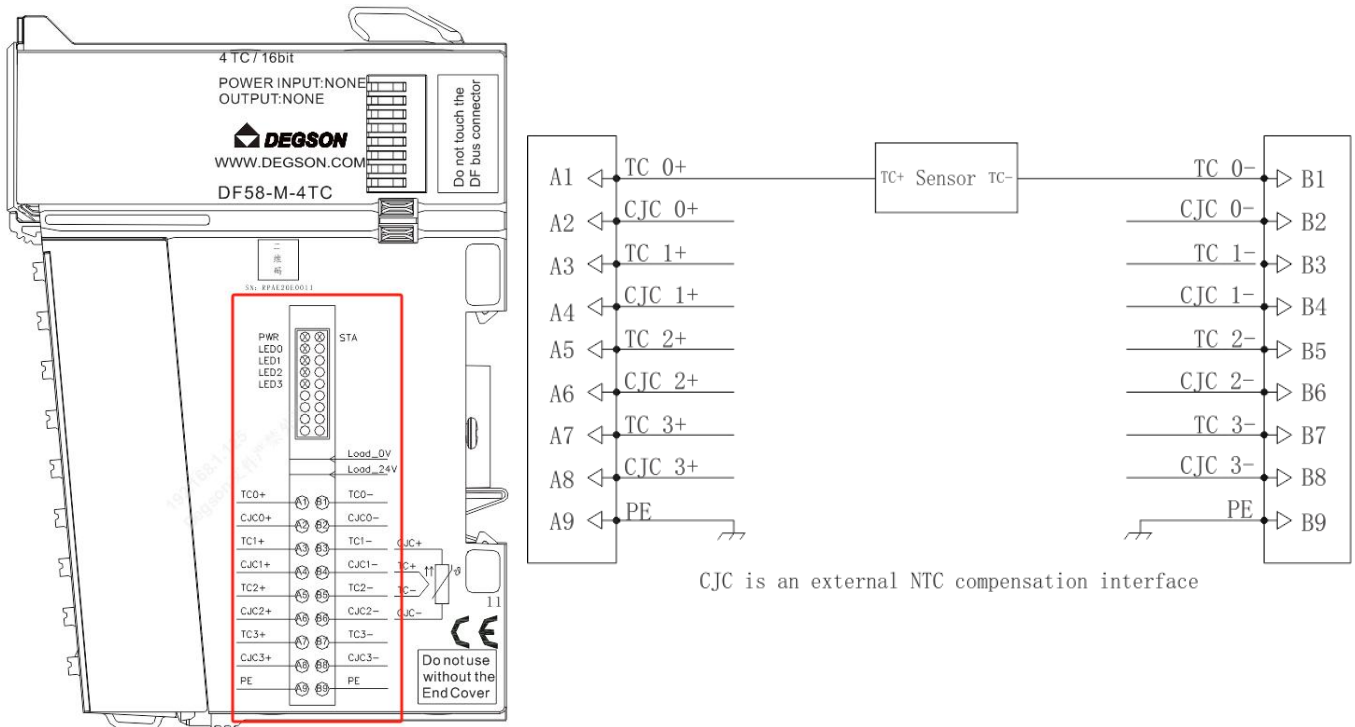

### 3.7.3. Module parameters

DF58-M-4TC module parameters

The name of the module	Enter the number of bytes	Number of bytes output
DF58-M-4TC	10	3

#### 3.7.3.1. Input Parameter Definition

The input address consists of the input area + diagnostic information area, which is shown in the following table

Type/Total Bytes	region	Number of bytes occupied (The number of bytes in the corresponding area is sorted in descending order)	illustrate
INPUT/10BYTE	INPUT	THE 1~2BYTE	Channel 1 enters the address

	AREA/8BYTE	THE 3~4BYTE	Enter the address in channel 2
		THE 5TH~6BYTE	Enter the address for channel 3
		THE 7~8BYTE	Enter the address in channel 4
	DIAGNOSTIC INFORMATION AREA/2BYTE	THE 9BYTE	Bit0: 1: Bus fault 0: Normal Bit1: 1: Channel 1 is disconnected or exceeds the upper and lower limits 0: Normal Bit2: 1: Channel 2 is disconnected or exceeds the upper and lower limits 0: Normal Bit3: 1: Channel 3 is disconnected or exceeds the upper and lower limits 0: Normal Bit4: 1: Channel 4 is disconnected or exceeds the upper and lower limits 0: Normal Bit5~Bit7: Reserved
		THE 10BYTE	reserve

### 3.7.3.2. Output parameter definition

The output address consists of the output area + parameter configuration area, as shown in the following table

Type/Total Bytes	region	Number of bytes occupied (The number of bytes in the corresponding area is sorted in descending order)	illustrate
OUTPUT/3BYTE	PARAMETER CONFIGURATION AREA/3 BYTES	1st Byte	Bit0: cold junction compensation switch 0: Enabled 1: Closed

			Bit1: cold end compensation 0: internal compensation 1: External compensation Bit2-bit3: reserve Bit4: Disconnection detection switch 0: Enabled 1: Closed
		2nd byte	reserve
		3rd byte	Set up 4 channel thermocouple detection types: Bit0~Bit7: 0: J type; 1: Type K; 2: E type; 3: T-type; 4: S-type; 5: R-type; 6: Type B (not supported yet); 7: N-type; 8: Type C (not supported yet); 9: L-type (not supported yet); 10: U-shaped (not supported yet); 11: $\pm 15.625\text{mv}$ ; 12: $\pm 31.25\text{mv}$ ; 13: $\pm 62.5\text{mv}$ ; 14: $\pm 125\text{mv}$ ; 15: $\pm 250\text{mv}$ ; 16: $\pm 500\text{mv}$ ; 17: $\pm 1000\text{mv}$ ; 18: $\pm 2000\text{mV}$ (not supported yet);

### 3.7.4. Mechanical installation

#### 3.7.4.1. Installation dimensions

The installation size information is shown in the figure below, and the unit is (mm).

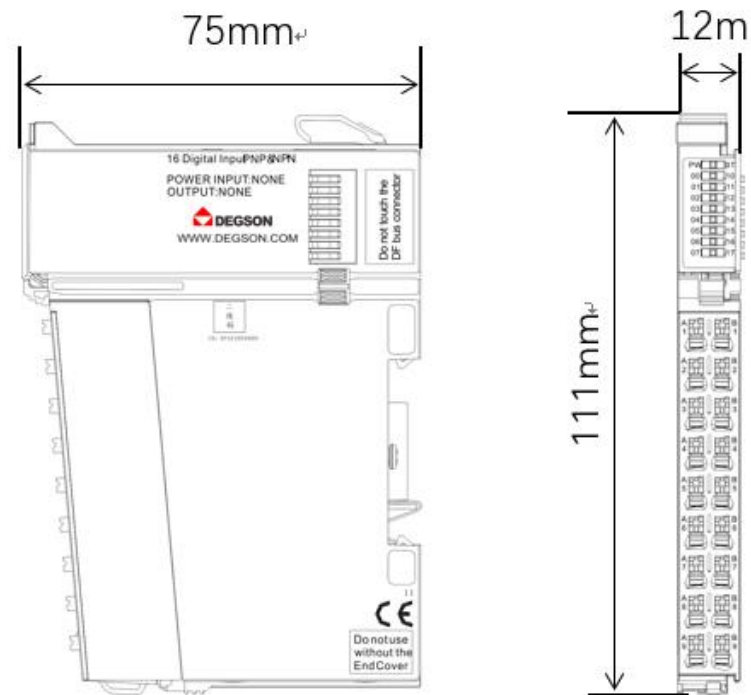

### 3.8. 8-channel thermocouple measurement (DF58-M-8TC)

- The module uses 4-channel thermocouple measurements and supports K/E/T/J/B/S/R/N/L types.
- Supports 2-wire sensors.
- The two LED indicators indicate that the module is operating normally and the communication is normal, respectively.
- Each channel has an LED indicator.
- Magnetic isolation between the field layer and the system layer.
- Transmitted in 16 resolutions.
- IP20 degree of protection.



### 3.8.1. Specifications

Specifications		
Model	DF58-M-8TC	
Product Description:	Thermocouple module, 8 inputs, 16-bit resolution	
Measuring range	thermocouple	
Number of channels	8	
Signal type	E(-200 ~ 1000°C),S(-50 ~ 1,768°C),J(-210 ~ 1,200°C) T(-200~400°C),K(-200~1.372°C) N(-200 ~ 1300°C), R(-50 ~ 1,768°C) ±15.625mV、±31.25mV、±62.5mV、±125mV、±250mV、±500mV、 ±1V	
Internal resistance	1 MΩ	
Cold junction compensation	Internal NTC compensation	
Module diagnostics	Yes	
Temperature coefficient	≤ 50 ppm/K	
Connection type	2-wire system	
Reverse polarity protection	Yes	
Isolation method	Magnetically isolated from the field layer	
Data size	16 Byte	
Error diagnosis	YES	
Single module diagnostics	YES	
Internal resistance	> 500KΩ	
resolution	16bit, 0.1 °C/per digit	
Margin of error	Operational errors	±0.5%
	Fundamental error	±0.5% @ 25°C
	Temperature error	±0.005%/K
	Linearity error	±0.05%/K
	The repeatability is in steady state	±0.05%/K
Data size	2 Byte	
Measuring range	-32768~32767	
precision	±0.2% FSR / 0.3% FSR for nickel sensors / 0.6% FSR for Cu10	
Power supply parameters		
Connection	PUSH-IN terminal blocks	
Operating voltage	24V DC +20%/ -15%	
System feed current	<150mA	
The maximum crimping area of	1.5mm <sup>2</sup>	

the wire	
Maximum crimping area of conductor (AWG)	AWG16
The minimum crimping area of the wire	0.14mm <sup>2</sup>
Minimum crimp area (AWG) of conductor	AWG26
Dial length	8...9mm
The maximum crimping area of the wire	1.5mm <sup>2</sup>
<b>Mechanical structure</b>	
Ingress protection	IP20
Dimensions (H X W X D)	
Rail type	35mm DIN
<b>Working environment</b>	
Operating temperature	-25... 60°C
Storage temperature	-40... 85°C
relative humidity	5... 95% RH (non-condensing)



### 3.8.2. Hardware interface

#### 3.8.2.1. Definition of terminal block

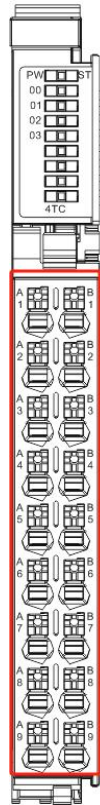

Terminal serial number	Signal	Terminal serial number	Signal	illustrate
A1	TC0+	B1	TC0-	Channel 0 thermocouple terminals
A2	TC1+	B2	TC1-	Channel 1 thermocouple terminals
A3	TC2+	B3	TC2-	Channel 2 thermocouple terminals
A4	TC3+	B4	TC3-	Channel 3 thermocouple terminals
A5	TC4+	B5	TC4-	Channel 4 thermocouple terminals
A6	TC5+	B6	TC5-	Channel 5 thermocouple terminals
A7	TC6+	B7	TC6-	Channel 6 thermocouple

				terminals
A8	TC7+	B8	TC7-	Channel 7 thermocouple terminals
A9	PE	B9	PE	earth

### 3.8.2.2. LED indicator definition

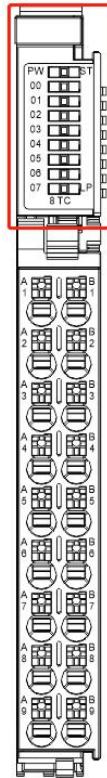

Light	meaning
PW (green)	Bright: The internal bus power supply is normal Off: The internal bus power supply is abnormal
STA (red)	Backplane bus communication fault alarm indication: Solid on: Bus communication failure Off: Normal.
00 (green)	Channel 1 Indicator: Flashing: Normal sampling, Solid: Exceeding upper and lower limits: Extinguished: disconnected;
01 (green)	Channel 2 Indicator: Flashing: Normal sampling, Solid: Exceeding upper and lower limits: Extinguished: disconnected;
02 (green)	Channel 3 Indicator: Flashing: Normal sampling, Solid: Exceeding upper and lower limits: Extinguished: disconnected;
03 (green)	Channel 4 Indicator: Flashing: Normal sampling, Solid: Exceeding upper and lower limits: Extinguished: disconnected;
04 (green)	Channel 5 Indicator:

	Flashing: Normal sampling, Solid: Exceeding upper and lower limits: Extinguished: disconnected;
05 (green)	Channel 6 Indicator: Flashing: Normal sampling, Solid: Exceeding upper and lower limits: Extinguished: disconnected;
06 (green)	Channel 7 Indicator: Flashing: Normal sampling, Solid: Exceeding upper and lower limits: Extinguished: disconnected;
07 (green)	Channel 8 Indicator: Flashing: Normal sampling, Solid: Exceeding upper and lower limits: Extinguished: disconnected;

### 3.8.2.3. Wiring diagram

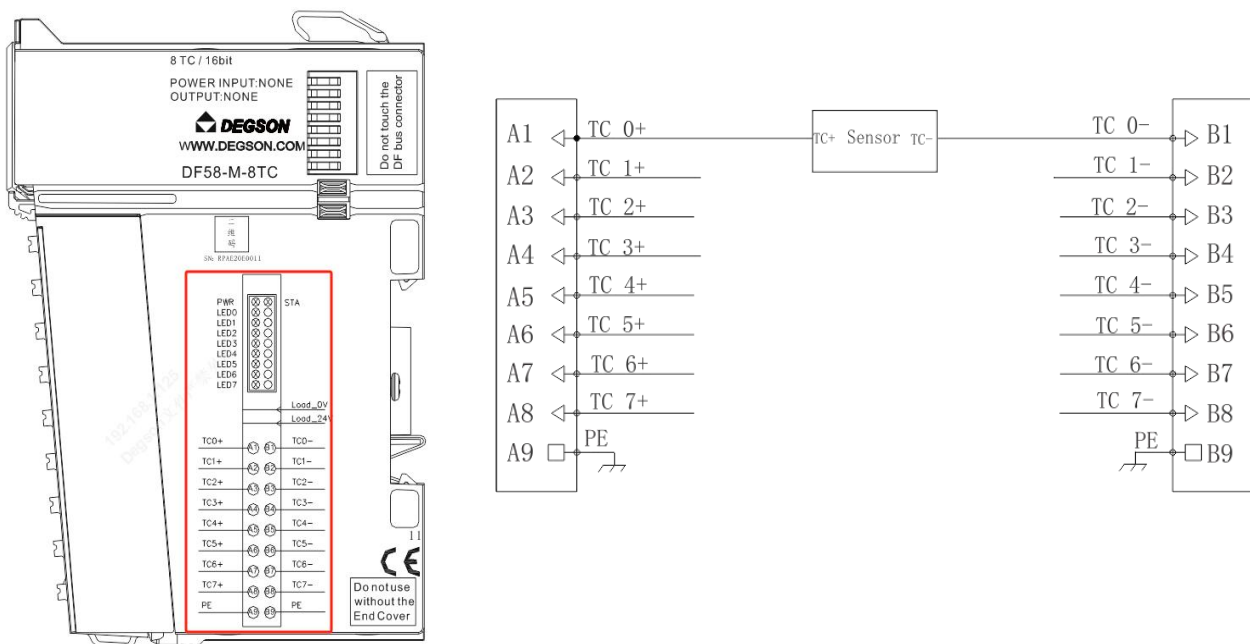

### 3.8.3. Module parameters

DF58-M-8TC module parameters

The name of the module	Enter the number of bytes	Number of bytes output
DF58-M-8TC	18	3

### 3.8.3.1. Input Parameter Definition

The input address consists of the input area + diagnostic information area, which is shown in the following table

Type/Total Bytes	region	Number of bytes occupied (The number of bytes in the corresponding area is sorted in descending order)	illustrate
	INPUT AREA/16BYTE	THE 1~2BYTE	Channel 1 enters the address
		THE 3~4BYTE	Enter the address in channel 2
		THE 5TH~6BYTE	Enter the address for channel 3
		THE 7~8BYTE	Enter the address in channel 4
		THE 9~10BYTE	Enter the address for channel 5
		THE 11~12BYTE	Channel 6 input address
		THE 13~14BYTE	Channel 7 enters the address
		THE 15~16BYTE	Channel 8 enters the address
INPUT/10BYTE	DIAGNOSTIC INFORMATION AREA/2BYTE	1BYTE	Bit0: 1: Bus fault 0: Normal Bit1: 1: Channel 1 is disconnected or exceeds the upper and lower limits 0: Normal Bit2: 1: Channel 2 is disconnected or exceeds the upper and lower limits 0: Normal Bit3: 1: Channel 3 is disconnected or exceeds the upper and lower limits 0: Normal Bit4:

Type/Total Bytes	region	Number of bytes occupied (The number of bytes in the corresponding area is sorted in descending order)	illustrate
			1: Channel 4 is disconnected or exceeds the upper and lower limits 0: Normal Bit5: 1: Channel 5 is disconnected or exceeds the upper and lower limits 0: Normal Bit6: 1: Channel 6 is disconnected or exceeds the upper and lower limits 0: Normal Bit7: 1: Channel 7 is disconnected or exceeds the upper and lower limits 0: Normal
		1BYTE	Bit0: 1: Channel 8 is disconnected or exceeds the upper and lower limits 0: Normal bit1~bit7: reserved

### 3.8.3.2. Output parameter definition

The output address consists of the output area + parameter configuration area, as shown in the following table

Type/Total Bytes	region	Number of bytes occupied (The number of bytes in the corresponding area is sorted in descending order)	illustrate
OUTPUT/3BYTE	PARAMETER CONFIGURATION AREA/3 BYTES	1st Byte	Bit0: cold junction compensation switch 0: On; 1: Closed; Bit1: reserve. Bit2-bit3: reserve Bit4: Disconnection detection switch 0: On; 1: Closed;
		2nd byte	reserve
		3rd byte	Set up 8 channel thermocouple detection types: Bit0~Bit7: 0: J type; 1: Type K; 2: E type; 3: T-type; 4: S-type; 5: R-type; 6: Type B (not supported yet); 7: N-type; 8: Type C (not supported yet); 9: L-type (not supported yet); 10: U-shaped (not supported yet); 11: $\pm 15.625\text{mv}$ ; 12: $\pm 31.25\text{mv}$ ; 13: $\pm 62.5\text{mv}$ ; 14: $\pm 125\text{mv}$ ; 15: $\pm 250\text{mv}$ ;

Type/Total Bytes	region	Number of bytes occupied (The number of bytes in the corresponding area is sorted in descending order)	illustrate
			16:±500mv; 17:±1000mv; 18:±2000mV (not supported yet);

### 3.8.4. Mechanical installation

#### 3.8.4.1. Installation dimensions

The installation size information is shown in the figure below, and the unit is (mm).

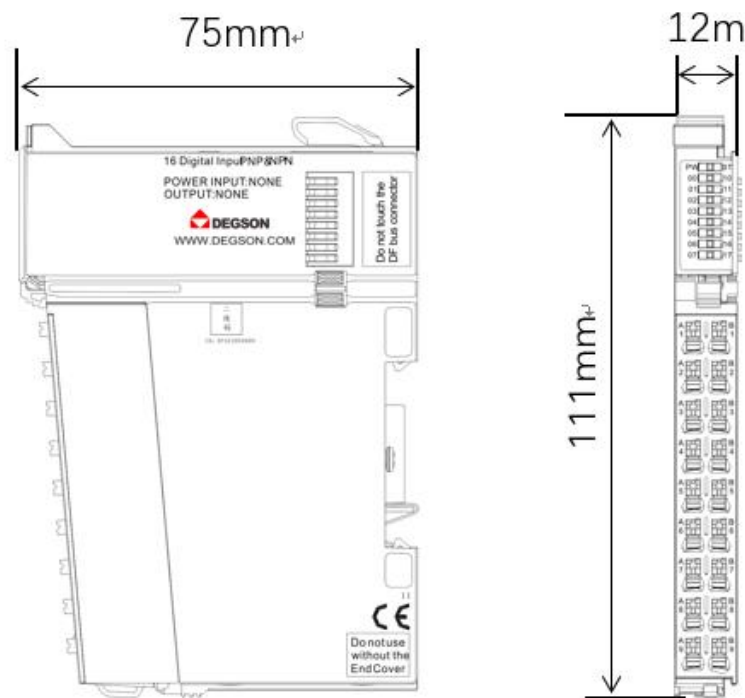



### 3.9. Encoder pulse count/24VDC (DF58-M-2CNT-PIL-24).

- The pulse counting module uses 2-channel pulse counting. The input signal voltage is 24VDC.
- Each input module is equipped with an anti-interference filter.
- The two LED indicators indicate that the module is operating normally and the communication is normal, respectively.
- Magnetic isolation between the field layer and the system layer.
- IP20 degree of protection.

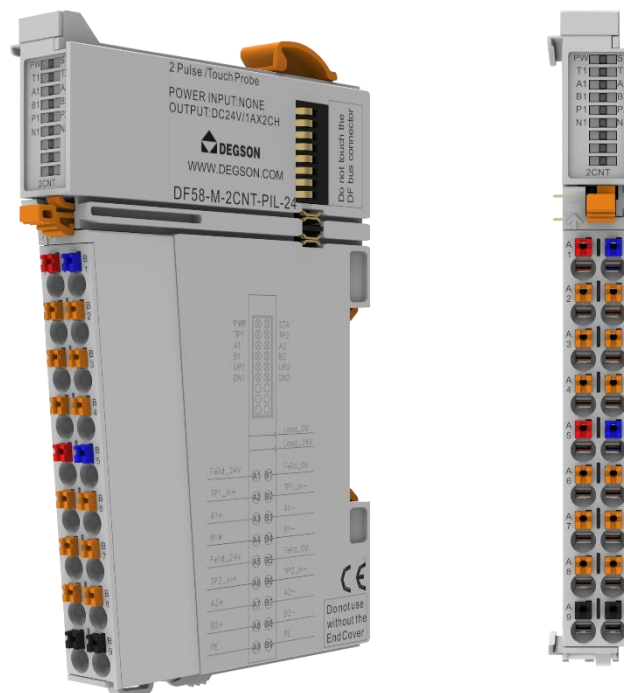

### 3.9.1. Specifications

Specifications	
Model	DF58-M-2CNT-PIL-24
Product Description:	Pulse counting module, 2 channels
Maximum count frequency	1Mhz
Number of channels	2
Input signal type	Incremental encoder AB or Pulse/Direction signal
Input signal voltage	24V DC
Enter the connection type	4-wire / 2-wire
Reverse circuit protection	Yes
Isolation method	Isolated from field layer optocouplers
Data size	20 Byte
Frequency multiplication mode	x1/x4
Filtering time	configurable, 0.01 to 1 ms
DI on voltage	Min.5Vdc to Max.28Vdc
DI off voltage	Max.2.7Vdc
DI turns on the current	Max.10mA/channel @28V
DI input impedance	=2.7kΩ
Sensor powered	500mA@5V, 500mA@24V
Error diagnosis	Yes, us responds, and the error code can be queried by the upper computer
resolution	32 Bit
Measuring range	Encoder: -2147483648~2147483647
precision	±1 press
Power supply parameters	
System feed current	<100mA
Mechanical structure	
Ingress protection	IP20
Rail type	35mm DIN
Environmental requirements	
Operating temperature	-25... 60°C
Storage temperature	-40... 85°C
relative humidity	5... 95% RH (non-condensing)
Pollution level	2. Comply with IEC 61131-2 standard
Working altitude	0 ... 2000 m
Vibration-resistant	4g, according to IEC 60068-2-6
Impact-resistant	15g,IEC 60068-2-27

EMC - Interference immunity	Complies with EN 61000-6-2
EMC - Radiated Interference	Complies with EN 61000-6-3
Corrosion resistance	IEC 60068-2-42 and IEC 60068-2-43 compliant
Permissible H2S pollutant concentration at 75 % relative humidity	10ppm
Permissible SO2 pollutant concentration at 75 % relative humidity	25ppm
Firmware upgrades	Yes

### 3.9.2. Hardware interface

#### 3.9.2.1. Definition of terminal block

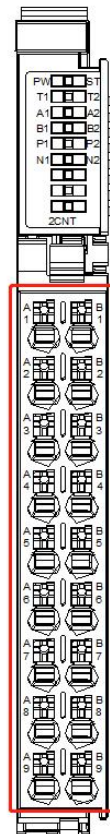

Terminal serial	Signal	Terminal serial	Signal
-----------------	--------	-----------------	--------

number		number		
A1	24V	B2	0V	24V power output
A2	TP1_in+	B3	TP1_in-	Channel 1 latched signal input (24V)
A3	A1+	B4	A1-	Channel 1 A signal input (24V)
A4	B1+	B5	B1-	Channel 1 B signal input (24V)
A5	24V	B6	0V	24V power output
A6	TP2_in+	B7	TP2_in-	Channel 2 latched signal input (24V)
A7	A2+	B8	A2-	Channel 2 A signal input (24V)
A8	B2+	B9	B2-	Channel 2 B signal input (24V)
A9	ON	B2	ON	earth

### 3.9.2.2. LED indicator definition

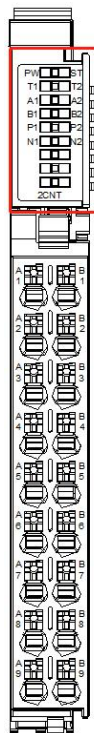

Light	meaning
PW (green)	Bright: The internal bus power supply is normal Off: The internal bus power supply is abnormal
STA (red)	Backplane bus communication fault alarm indication: Solid on: Bus communication failure Off: Normal.
T1 (green)	Channel 1 latches the signal indicator. Bright: The latch is successful. Off: No latching is performed.
T2 (green)	Channel 2 latches the signal indicator. Bright: The latch is successful.

	Off: No latching is performed.
A1 (green)	Channel 1 Encoder A Signal Indicator: On: The input signal is valid Off: The input signal is invalid
B1 (green)	Channel 1 Encoder B Signal Indicator: On: The input signal is valid Off: The input signal is invalid
A2 (green)	Channel 2 Encoder A Signal Indicator: On: The input signal is valid Off: The input signal is invalid
B2 (green)	Channel 2 Encoder B Signal Indicator: On: The input signal is valid Off: The input signal is invalid
P1 (green)	On: Encoder 1 rotates forward Off: Encoder 1 is stationary or rotates in the opposite direction
P2 (green)	On: Encoder 2 rotates forward Off: Encoder 2 is stationary or rotates in the opposite direction
N1 (green)	On: Encoder 1 rotates in reverse Off: Encoder 1 is stationary or rotates in a forward direction
N2 (green)	On: Encoder 2 rotates in reverse Off: Encoder 2 rotates stationary or forward
E1 (green)	Channel 1 Working Mode Indicator: On: The channel is in phase AB mode Off: The channel is in pulse/direction mode
E2 (green)	Channel 2 Working Mode Indicator: On: The channel is in phase AB mode Off: The channel is in pulse/direction mode

### 3.9.2.3. Wiring diagram

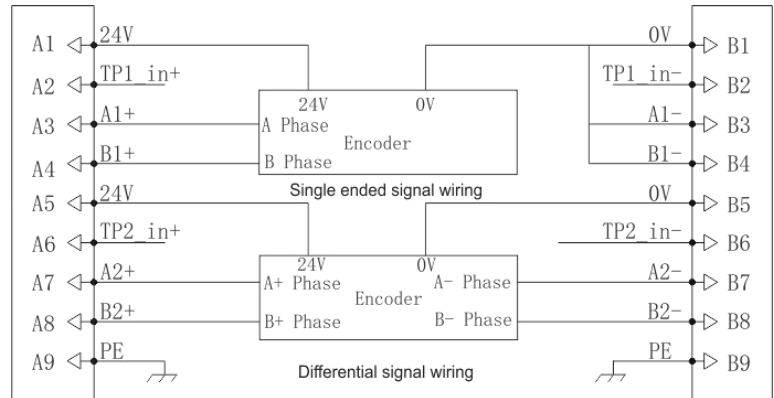
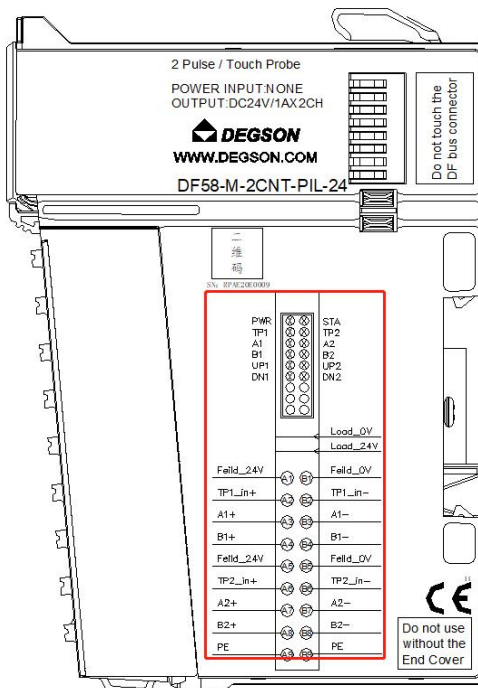

### 3.9.3. Module parameters

The name of the module	Enter the number of bytes	Number of bytes output
DF58-M-2CNT-PIL-24	20	14

#### 3.9.3.1. Input Parameter Definition

The input address consists of the input area + diagnostic information area, which is shown in the following table

Type/Total Bytes	region	Number of bytes occupied (The number of bytes in the corresponding area is sorted in descending order)	illustrate

Type/Total Bytes	region	Number of bytes occupied (The number of bytes in the corresponding area is sorted in descending order)	illustrate
INPUT/20BYTE	INPUT AREA/8BYTE	1st BYTE	Counter 1 Status: Bit0: phase A input Bit1: Phase B input Bit2: latching the success flag. Bit3: Encoder positive indication Bit4: Encoder inverted indication Bit5: 1: Overflowing on the current count value 0: After the count value is overflowed, the count value continues to exceed 5000. Bit6: 1: Overflow under the current count value 0: After the count value overflows, the count value continues down to exceed 5000. Bit7: The counter is preset successfully, and 1 is valid
		THE 2~5BYTE (DINT)	Counter 1: The current count value
		THE 6~9BYTE (DINT)	Counter 1 latches the value. (Depending on the configuration, the current count value is latched on the rising or falling edge of the TP signal)
		THE 10BYTE	Counter 2 Status: Bit0: phase A input Bit1: Phase B input Bit2: latching the success flag. Bit3: Encoder positive indication Bit4: Encoder inverted indication

Type/Total Bytes	region	Number of bytes occupied (The number of bytes in the corresponding area is sorted in descending order)	illustrate
			Bit5: 1: Overflowing on the current count value 0: After the count value is overflowed, the count value continues to exceed 5000. Bit6: 1: Overflow under the current count value 0: After the count value overflows, the count value continues down to exceed 5000. Bit7: The counter is preset successfully, and 1 is valid
		THE 11~14BYTE (DINT)	Counter 2: The current count value
		THE 15~18BYTE (DINT)	Counter 2 latches the value. (Depending on the configuration, the current count value is latched on the rising or falling edge of the TP signal)
	DIAGNOSTIC INFORMATION AREA/2BYTE	THE 19BYTE	Bit0: 1: Bus fault 0: The bus is normal Bit1: Reserved Bit2: 1: Channel 1 is out of phase, only the AB phase is in quadrature counting mode. 0: normal; Bit3: 1: Channel 2 is out of phase, only the AB phase is in orthogonal counting mode. 0: normal;



Type/Total Bytes	region	Number of bytes occupied (The number of bytes in the corresponding area is sorted in descending order)	illustrate
			bit4~bit7: reserved
		THE 20BYTE	reserve

### 3.9.3.2. Output parameter definition

The output address consists of the output area + parameter configuration area, as shown in the following table

Type/Total Bytes	region	Number of bytes occupied (The number of bytes in the corresponding area is sorted in descending order)	illustrate
OUTPUT/14BYTE	PARAMETER CONFIGURATION AREA/14 BYTES	1st Byte	Counter 1 sets the control parameters: BIT0:0: INVALID; 1: Set the counter preset value to the current count value; BIT1:0: INVALID; 1: clears the counter value; BIT2:0: INVALID; 1: Clear the overflow mark; BIT3:0: INVALID; 1: Clear the overflow mark; BIT4:0: INVALID; 1: TP signal rising edge latch count value, note that it is only latched once, if you need to start latching again, you need to set 0 to this parameter and then set 1

Type/Total Bytes	region	Number of bytes occupied (The number of bytes in the corresponding area is sorted in descending order)	illustrate
			again. Bit5:0: Invalid; 1: TP signal rising edge latch count value, note that it is only latched once, if you need to start latching again, you need to set 0 to this parameter and then set 1 again. Bit6~Bit7: Reserved;
		The 2~5Byte (DINT)	Counter 1 preset setting
		6th Byte	Counter 1 sets the channel parameters: Bit0~bit1: 0: AB phase 1 octave count 1: AB phase 4 octave counting 2: Pulse + direction counting Bit2: 0: counts upwards 1: Count downward Bit3: 0: Keep Last Value: The counter stops counting during an error (such as a backplane bus failure or AB phase loss) and will continue to count from the previous value once it resumes normal operation 1: The counter continues to count during the error Bit4~Bit7: Reserved
		7th Byte	Counter 1 Filter Settings:

Type/Total Bytes	region	Number of bytes occupied (The number of bytes in the corresponding area is sorted in descending order)	illustrate
			<p>0: No filtering;            1:0.01ms;            2:0.02ms;            3:0.03ms;            4:0.04ms;            5:0.05ms;            6:0.2ms;            7:0.4ms;            8:0.6ms;            9:0.8ms;            10:1.00ms;</p> <p>Counter 2 sets the control parameters:            BIT0:0: INVALID;            1: Set the counter preset value to the current count value;            BIT1:0: INVALID;            1: clears the counter value;            BIT2:0: INVALID;            1: Clear the overflow mark;            BIT3:0: INVALID;            1: Clear the overflow mark;            BIT4:0: INVALID;            1: TP signal rising edge latch count value, note that it is only latched once, if you need to start latching again, you need to set 0 to this parameter and then set 1 again.            Bit5:0: Invalid;            1: TP signal rising edge latch count value, note that it is only latched once, if you</p>
		8th Byte	

Type/Total Bytes	region	Number of bytes occupied (The number of bytes in the corresponding area is sorted in descending order)	illustrate
			<p>need to start latching again, you need to set 0 to this parameter and then set 1 again.</p> <p>Bit6~Bit7: Reserved.</p>
		The 9~12Byte (DINT)	Counter 2 preset setting (
		13th Byte	<p>Counter 2 sets the channel parameters:</p> <p>Bit0~bit1:</p> <p>0: AB phase 1st harmonic counting;</p> <p>1: AB phase 4th harmonic counting;</p> <p>2: Pulse + direction counting;</p> <p>Bit2:</p> <p>0: Count upward;</p> <p>1: Count downward;</p> <p>Bit3:</p> <p>0: Keep last value: The counter stops counting during an error (such as backplane bus failure or AB phase loss), once it resumes normal operation, the counter will continue to count from the previous value;</p> <p>1: The counter continues to count during the error;</p> <p>Bit4~Bit7: Reserved</p>
		14th Byte	<p>Counter 2 filter settings:</p> <p>0: No filtering;</p> <p>1:0.01ms;</p> <p>2:0.02ms;</p>

Type/Total Bytes	region	Number of bytes occupied (The number of bytes in the corresponding area is sorted in descending order)	illustrate
			3:0.03ms; 4:0.04ms; 5:0.05ms; 6:0.2ms; 7:0.4ms; 8:0.6ms; 9:0.8ms; 10:1.00ms;

### 3.9.4. Mechanical installation

#### 3.9.4.1. Installation dimensions

The installation size information is shown in the figure below, and the unit is (mm).

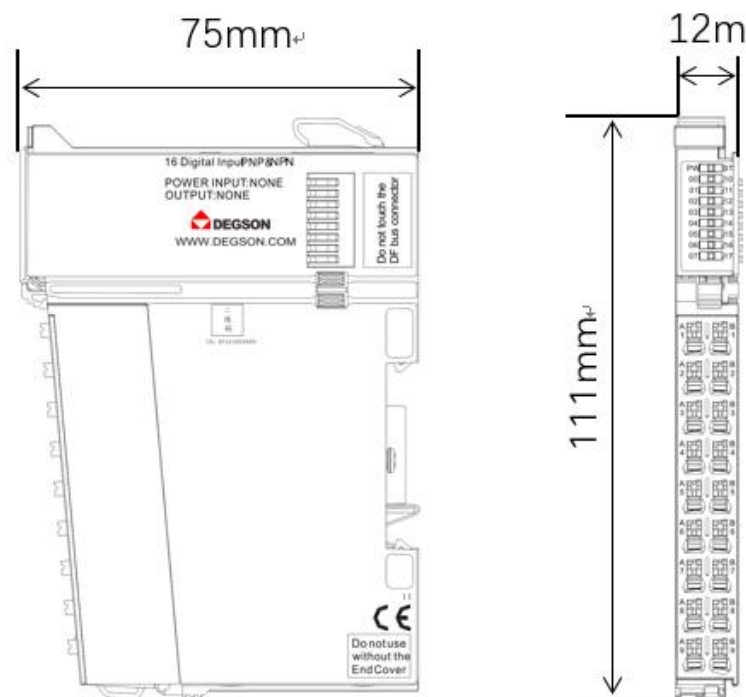

### 3.10. 24V to 5V Power isolation module (DF58-M-DC-U-5)

- The operating voltage of 5VDC for the I/O module is set by the internal bus of the module.
- Provides internal system current of 2A.
- 24VDC rated voltage for external sites.
- The two LED indicators indicate that the module is operating normally and the communication is normal, respectively.
- Galvanic isolation between the field layer and the system layer.
- IP20 degree of protection.



### 3.10.1. Specifications

Specifications	
Model	DF58-M-DC-U-5
Product Description:	24VDC to 5VDC
Number of channels	1
Isolation method	System power to field power: Isolation module
Power supply parameters	
Operating voltage	24V DC +20 %/ -15 % (IEC mode)
Anti-reverse polarity protection	YES
Over-temperature protection	YES
Overload protection	YES
Short-circuit protection	YES
Provides internal system voltage	5VDC
Internal system current is supplied	Max.2A@5V
The load voltage is provided	24V DC +20 %/ -15 % (IEC mode)
The maximum current of the load is supplied	10A
Load overvoltage protection	YES
Mechanical structure	
Ingress protection	IP20
Rail type	35mm DIN
Working environment	
Operating temperature	-25... 60°C
Storage temperature	-40... 85°C
relative humidity	5... 95% RH (non-condensing)
Pollution level	2. Comply with IEC 61131-2 standard
Working altitude	0 ... 2000 m
Vibration-resistant	4g, according to IEC 60068-2-6
Impact-resistant	15g, IEC 60068-2-27
EMC - Interference immunity	Complies with EN 61000-6-2
EMC - Radiated Interference	Complies with EN 61000-6-3
Corrosion resistance	IEC 60068-2-42 and IEC 60068-2-43 compliant
Permissible H <sub>2</sub> S pollutant concentration at 75 % relative humidity	10ppm

Permissible SO <sub>2</sub> pollutant concentration at 75 % relative humidity	25ppm
Firmware upgrades	Yes

### 3.10.2. Hardware interface

#### 3.10.2.1. Definition of terminal block

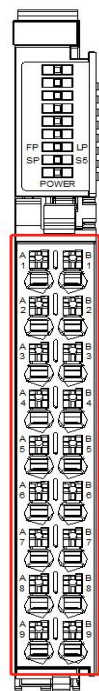

Terminal serial number	Signal	Terminal serial number	Signal	
A1	24V	B2	0V	24V power output
A2	24V	B3	0V	24V power output
A3	24V	B4	0V	24V power output
A4	24V	B5	0V	24V power output
A5	24V	B6	0V	24V power output
A6	24V	B7	0V	24V power output
A7	24V	B8	0V	24V power output
A8	24V	B9	0V	24V power input of the module
A9	PE	B2	PE	earth

**Note:** It is recommended to use two 24V power supplies isolated from each other to



provide 2 power supplies for the module to achieve optimal anti-interference performance.

### 3.10.2.2. LED indicator definition

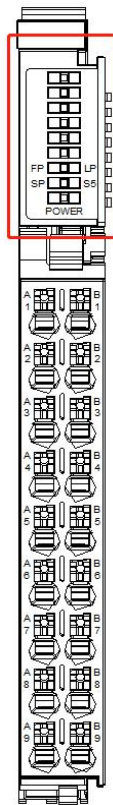

Light	meaning
FP (Green)	Green: The load power supply is running normally.
LP (Green)	Green: The sensor power supply is operating normally.
SP (green)	Green: The internal system power supply is running normally.
S5 (green)	Green: The internal 5V power supply is running normally.

### 3.10.2.3. Wiring diagram

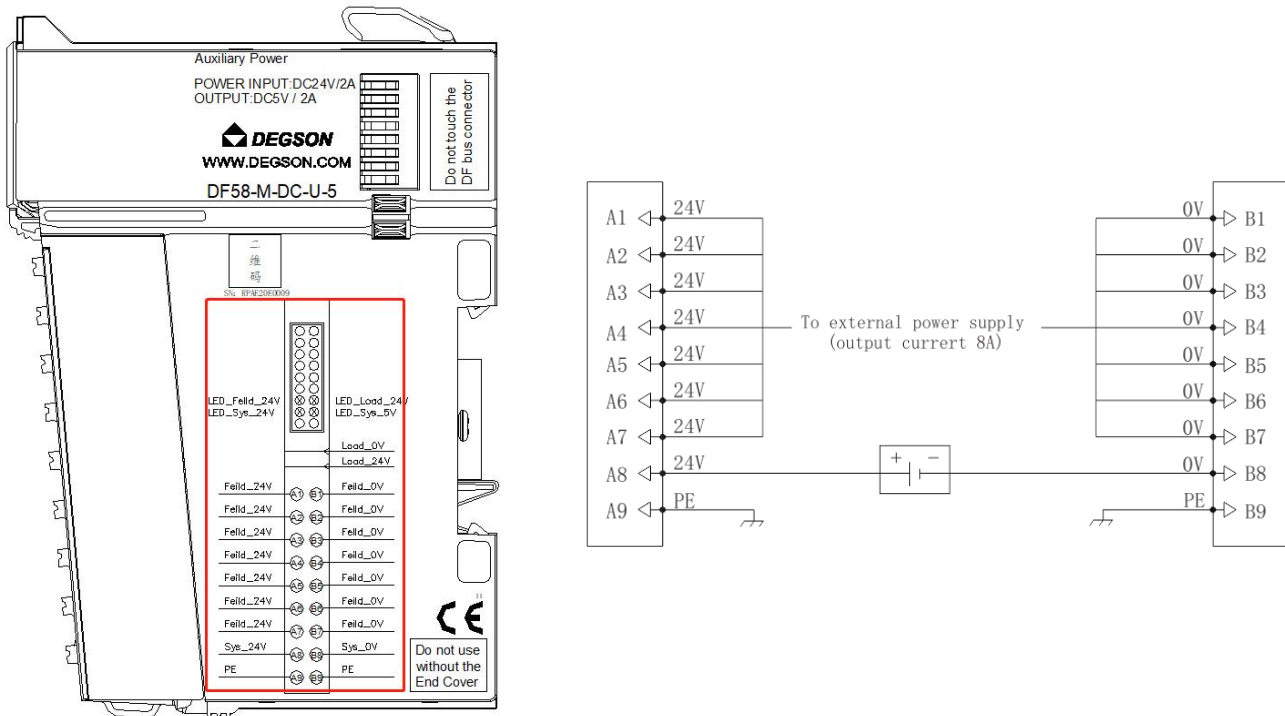

As shown in the image:

A8 external wiring 24v end, B8 external wiring 0v end, A9, B9 ground.

A1-B1 is one group of external power supply, and one group can support 7 groups of external 24V power supply.

### 3.10.3. Mechanical installation

#### 3.10.3.1. Installation dimensions

The installation size information is shown in the figure below, and the unit is (mm).

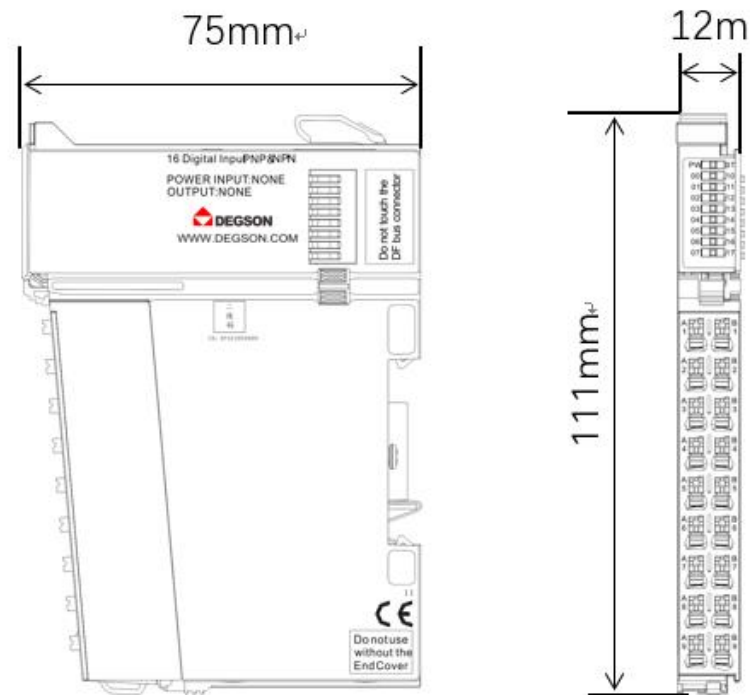

## 4. The use of examples

This document is intended to be a quick guide to the EtherNet/IP coupler DF58-C-EN-IP and DF58 series IO modules, and is intended to be used quickly by people with some engineering experience.

### 4.1. Sysmac Studio software EtherNet/IP simple instructions

#### 4.1.1. Communication Connections

Schematic diagram of the communication connection, as shown in the following figure:

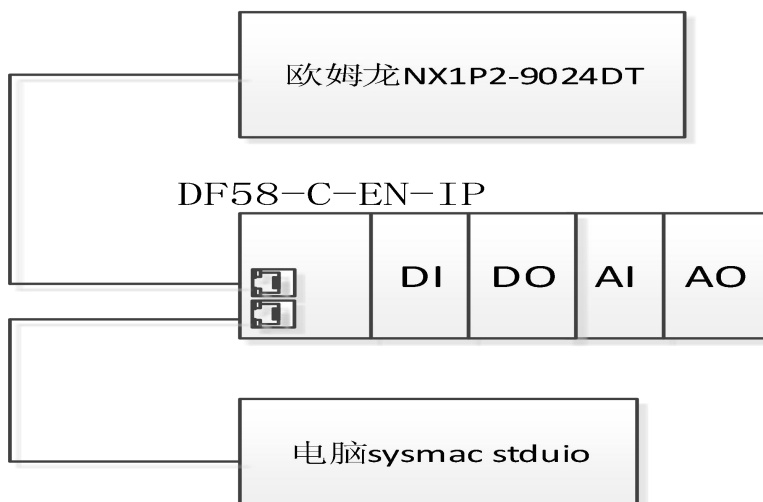

#### 4.1.2. Hardware configuration

hardware	quantity	remark
Programming a computer	1	Install Sysmac Studio
controller	1	Omron NX1P2-9024DT
DF58-C-EN-IP	1	EtherNet/IP protocol coupler
DF58-M-16DI-P/N	1	Expansion modules
DF58-M-16DO-P	1	Expansion modules
DF58-M-4AI-UI-6	1	Expansion modules
DF58-M-4AO-UI-6	1	Expansion modules
Cable	Several	
DC regulated power supply	1	Controller, module power supply

### 4.1.3.DF58-C-EN-IP configuration byte query

Method 1: Query the total bytes of DF58-C-EN-IP in NetModuleSearch. **We recommend that you use the NetModuleSearch tool to query the query.**

Method 2: Add the number of bytes occupied by each module, add the number of input bytes, add the number of output bytes, and calculate the total number of output bytes, and the input total is. For the number of bytes per module, please refer to the corresponding module parameters or Appendix II.

Use the NetModuleSearch tool to query the configuration information of DF58-C-EN-IP as shown in the following



figure:

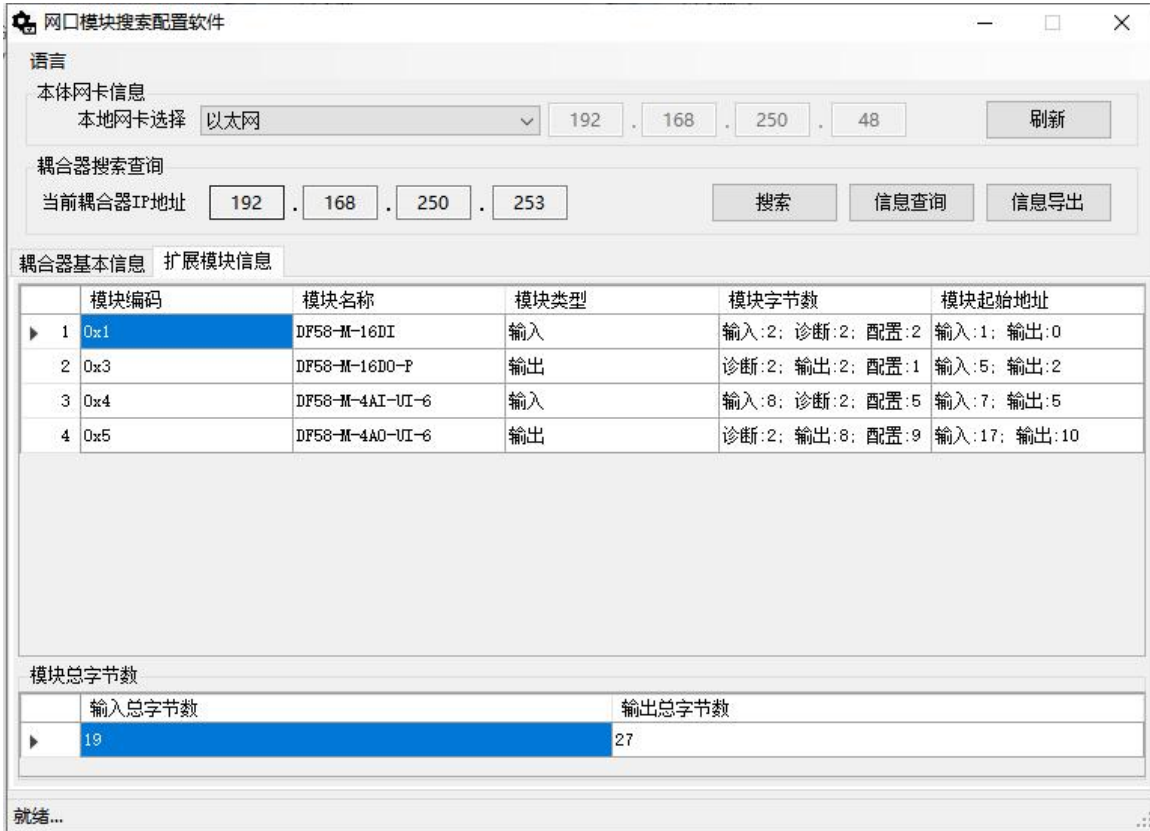

The name of the module	Enter the number of bytes	Number of bytes output	Module ID encoding
DF58-C-EN-IP	1Byte	0	
DF58-M-16DI	4Byte	2Byte	1
DF58-M-16DO-P	2Byte	3Byte	3
DF58-M-4AI-UI-6	10Byte	5Byte	4
DF58-M-4AO-UI-6	2Byte	17Byte	5
Total bytes	19Byte	27Byte	

### 4.1.4. New Projects



Open Sysmac Studio, create a new project, and select the appropriate device and version.

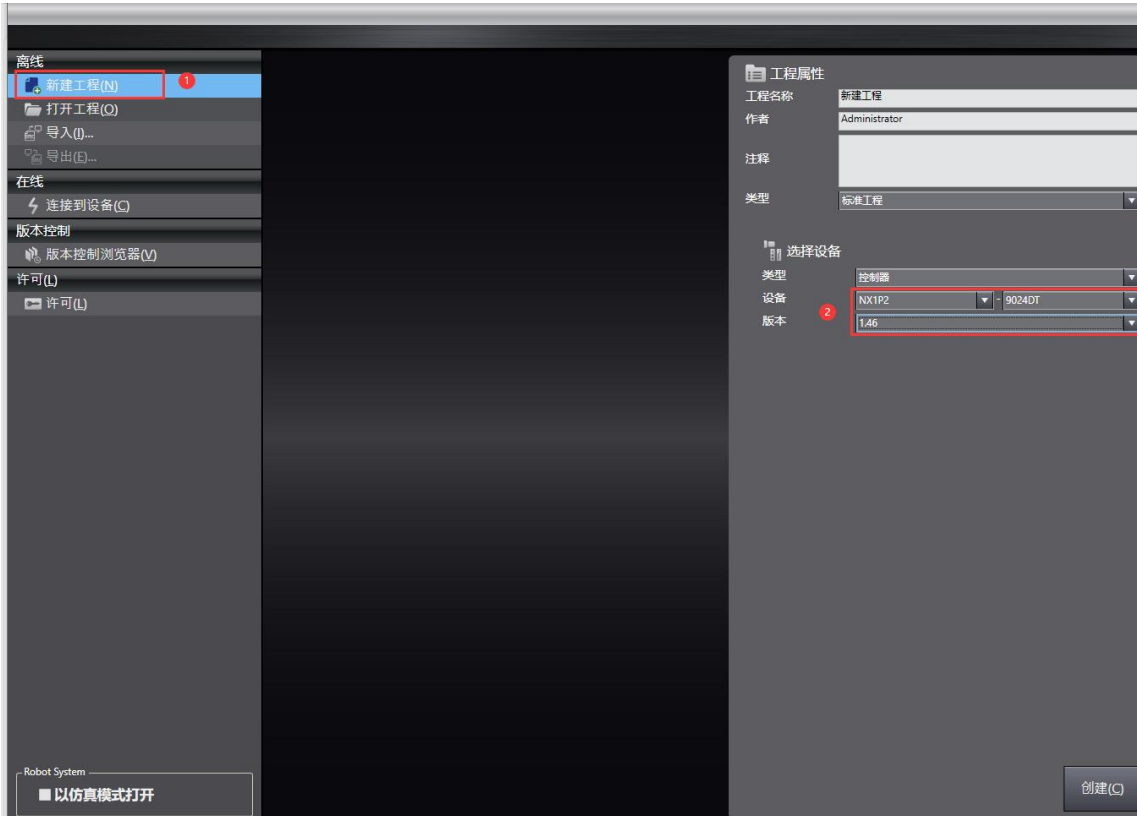

### 4.1.5. Add EDS files

Open the sysmac studio software, create a project, find "Tools (T)" in the menu bar, **EtherNet/IP connection settings**, and follow the steps below to add the DF58-C-EN-IP.EDS file

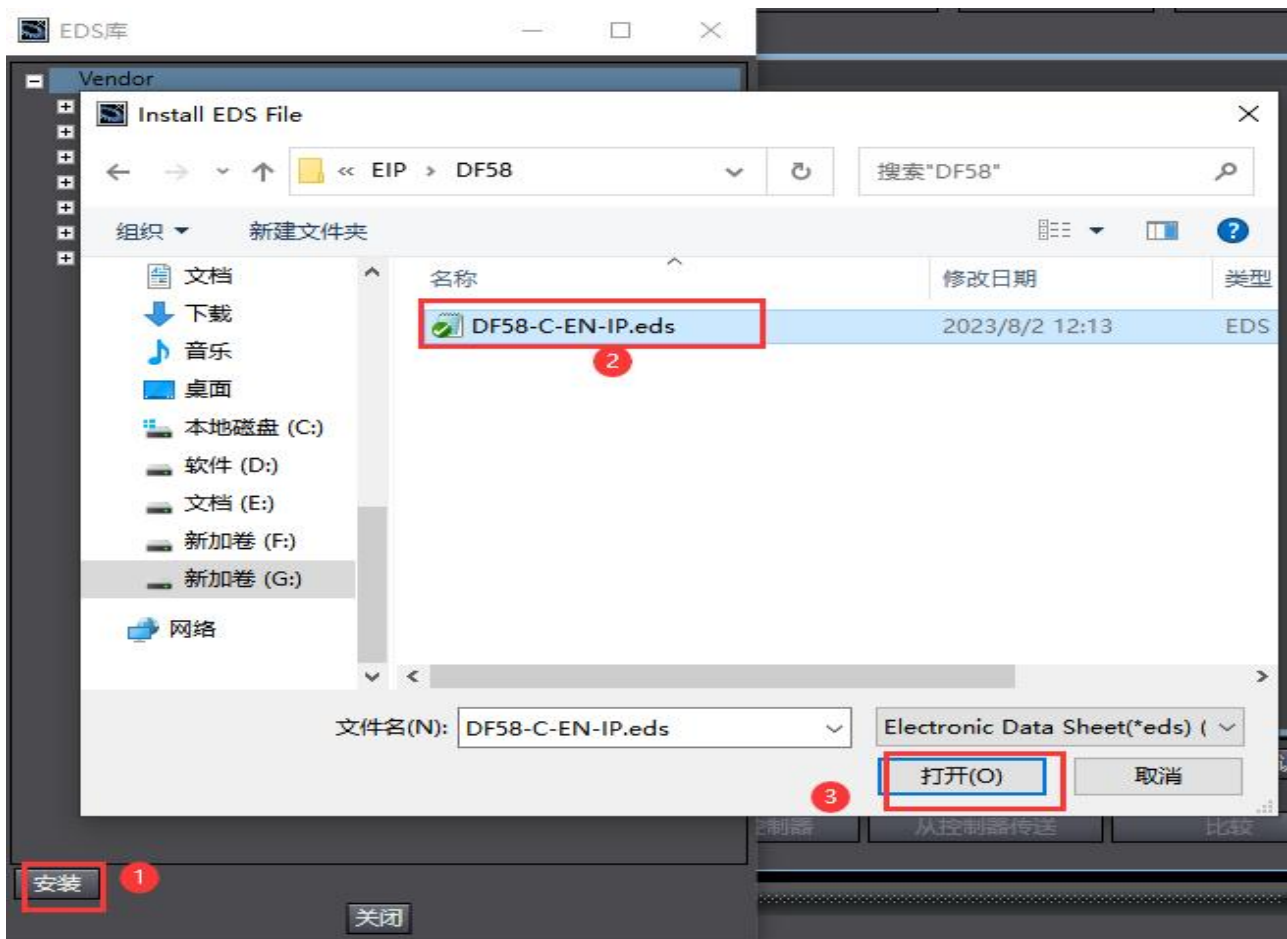
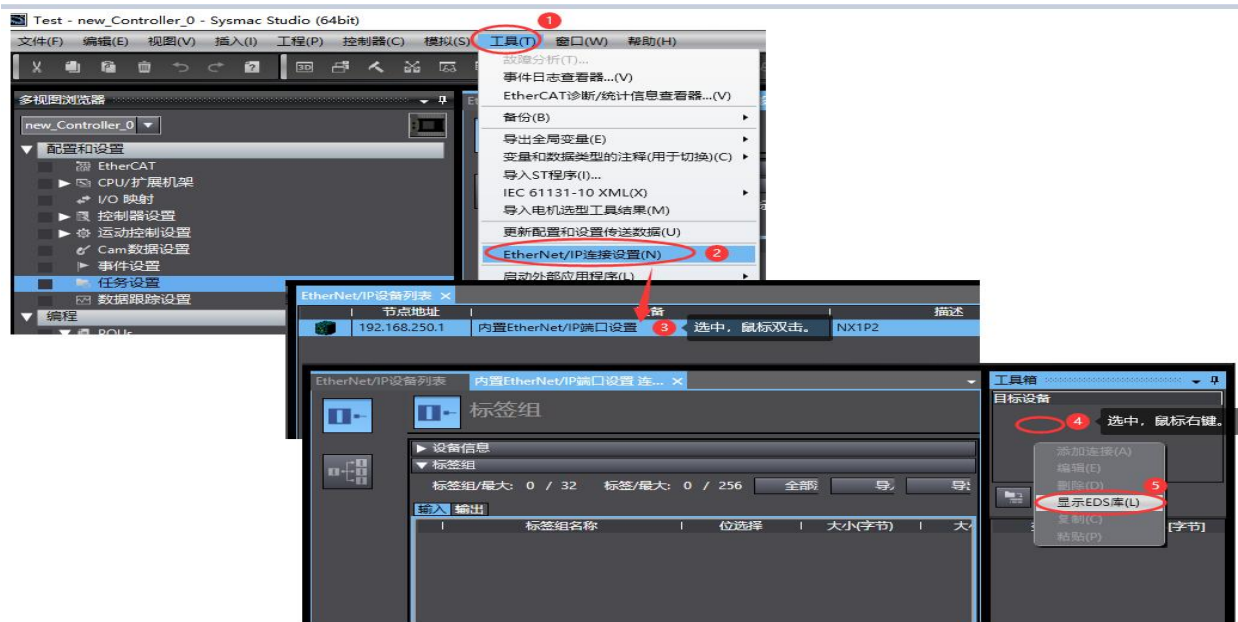

After the installation is successful, you can find the installed files in the EDS repository, as shown in the following figure:



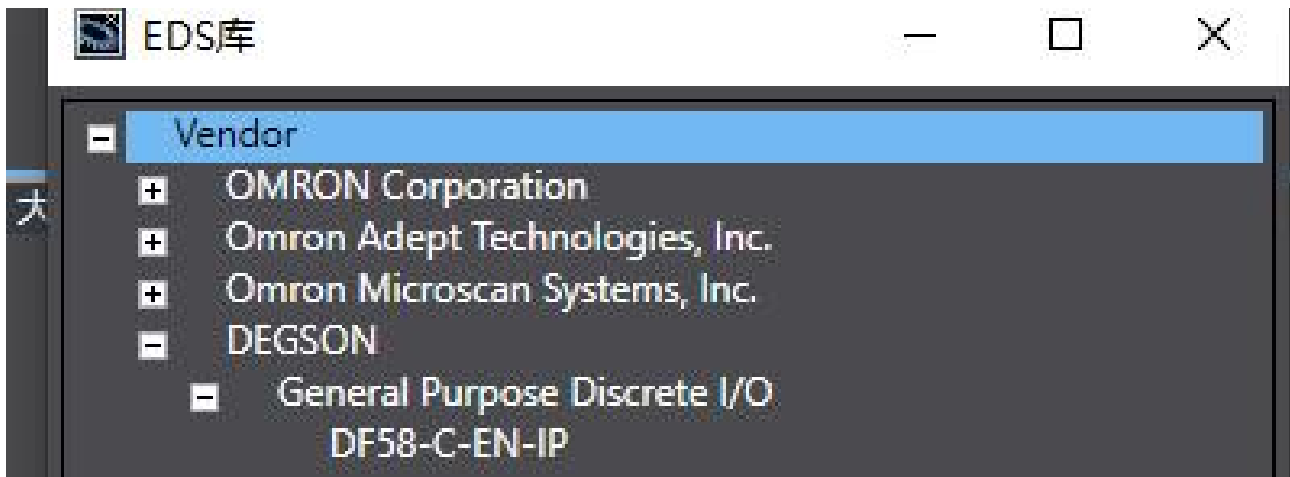

### 4.1.6. Add global variables

Open the "Global Variables" interface in the software, add two array variables, one for the input of the read coupler, one for the network to expose the selection input, one for the output of the write coupler, the network to expose the selection output, the length of the array needs to be consistent with the length of the input (InputData) and output (OutputData) set when adding the coupler, this time the purpose is to guide how to add variables, the number of bytes in the figure is defined by the actual module:

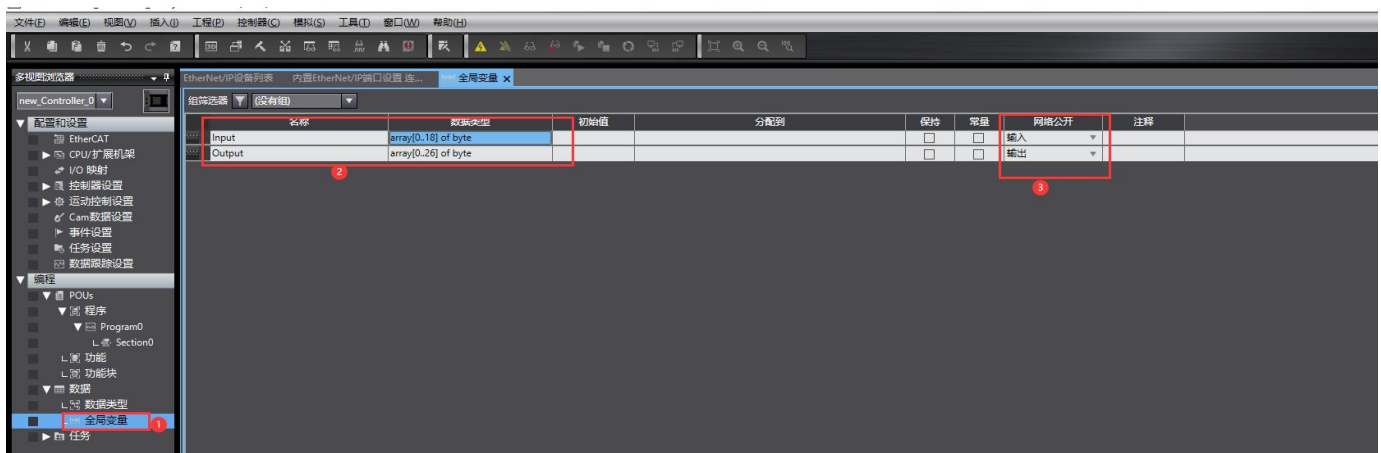

### 4.1.7. Add an EIP

Open Tools → Open EtherNet/IP Connection Settings and configure EtherNet/IP connection settings

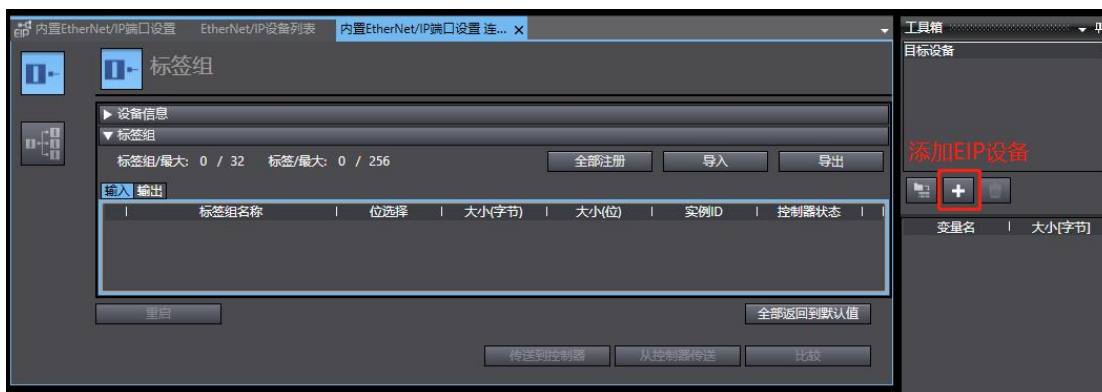
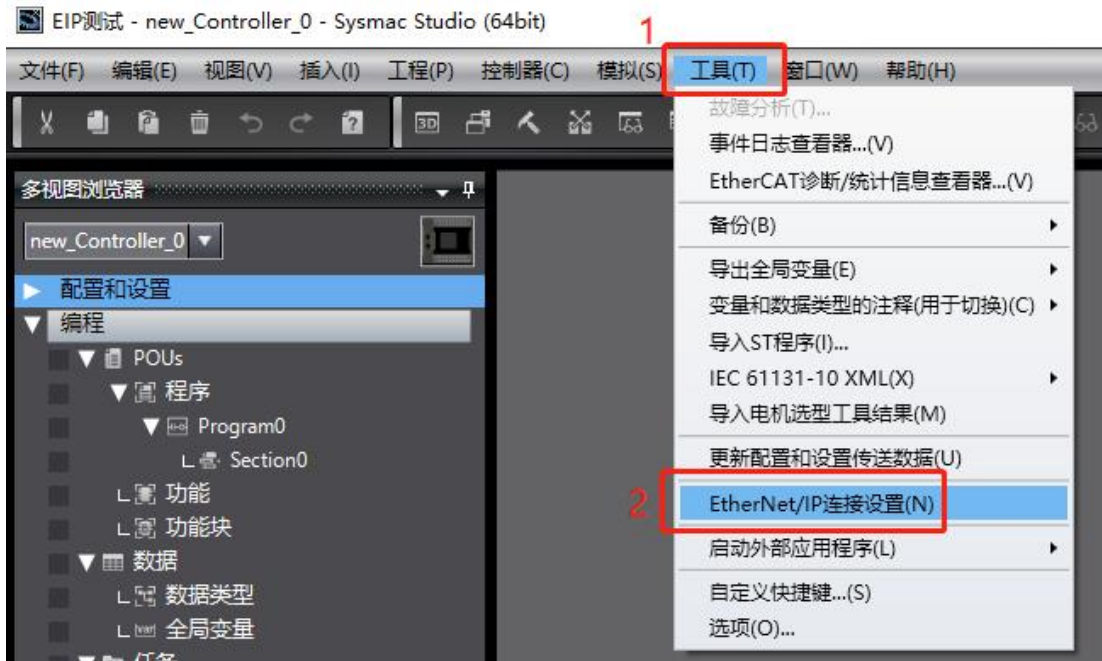

After the coupler is added, set the length of the input and output data to ensure that it is consistent with the established global variables.



### 4.1.8. Associated Variables

To register a variable in a global variable to a tag group:

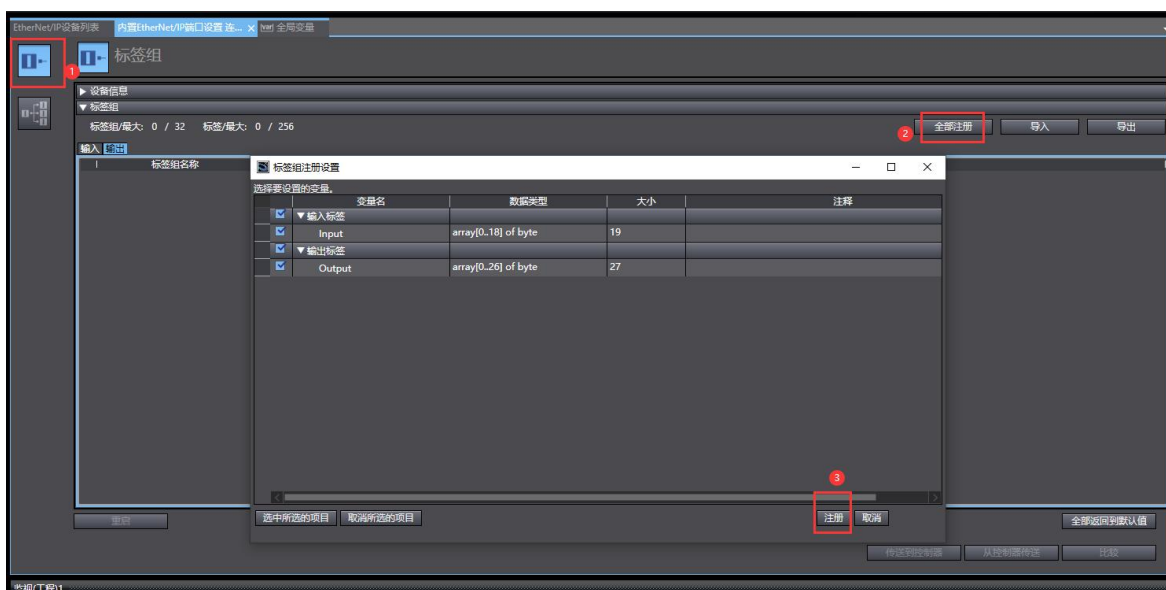



Click Open to add an EIP connection

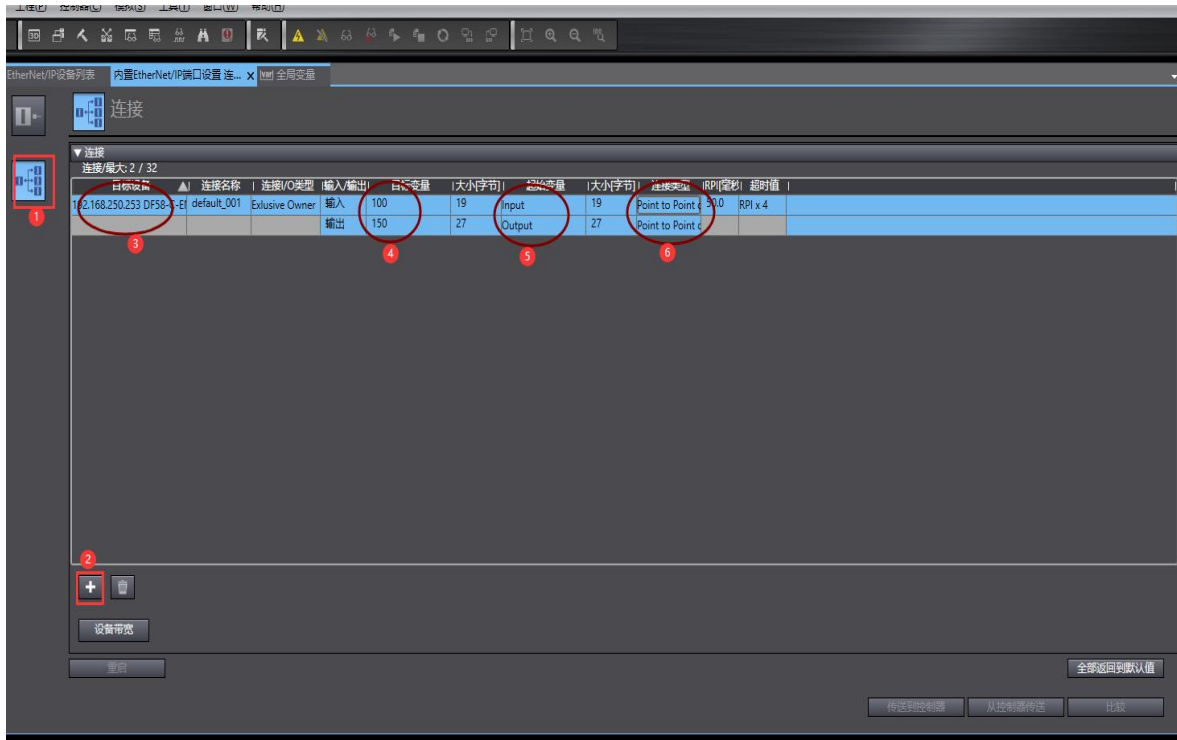

Click on the controller, select Transfer to Controller, download to CPU:

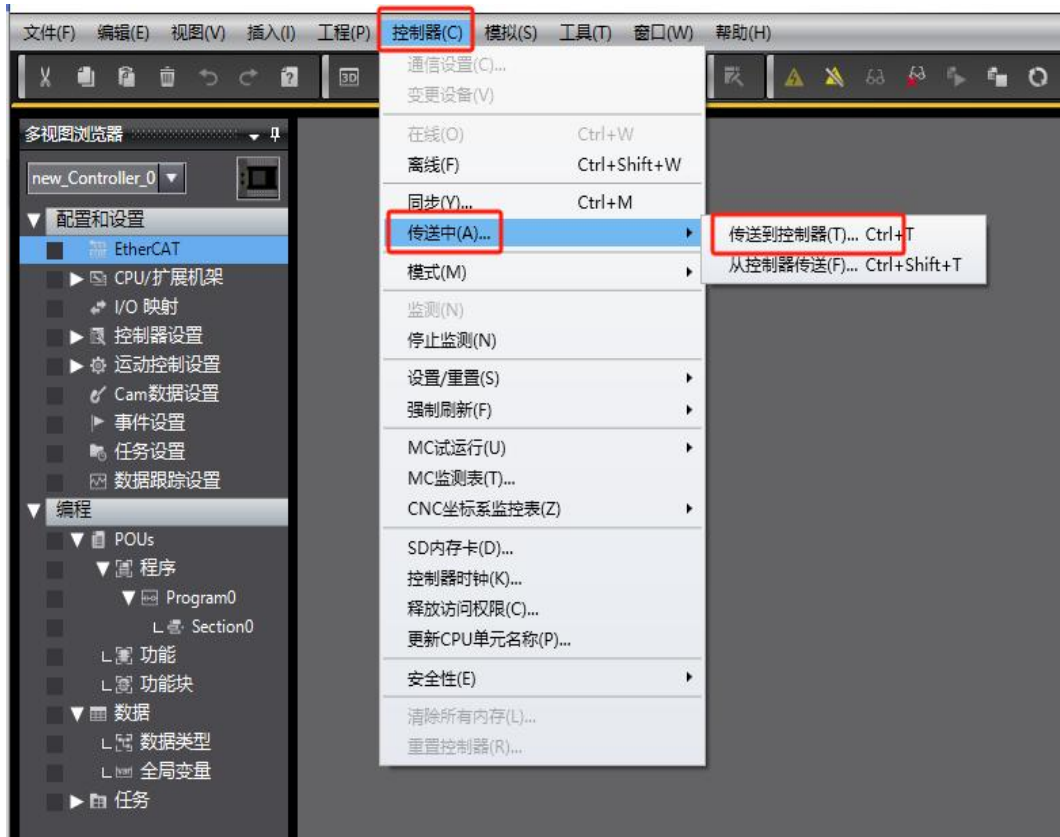

## 4.1.9.Downloads

Once the download is complete, select "Transfer to Controller" in the Built-in EtherNet/IP Port Settings Connection bar.

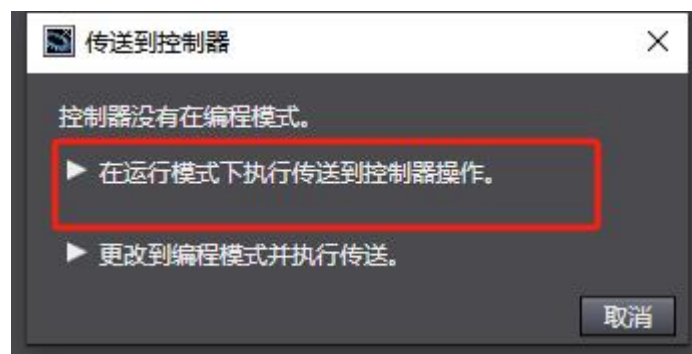
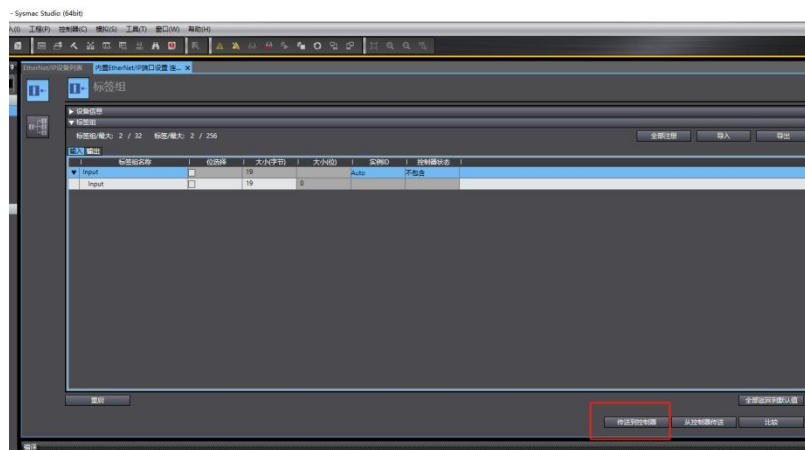

After the project is downloaded to the controller, the normal connection status of the controller is as shown in the figure, the PWR and NET indicators of the DF58-C-EN-IP module are lit, and the SF indicator is off, indicating that the DF58-C-EN-IP communicates successfully with the Omron controller at this time, and the DF58-C-EN-IP and its expansion module can be controlled.



#### 4.1.10. Data Monitoring

In the view bar, select a monitoring window to create a monitoring screen.



### 4.1.10.1. Output Area

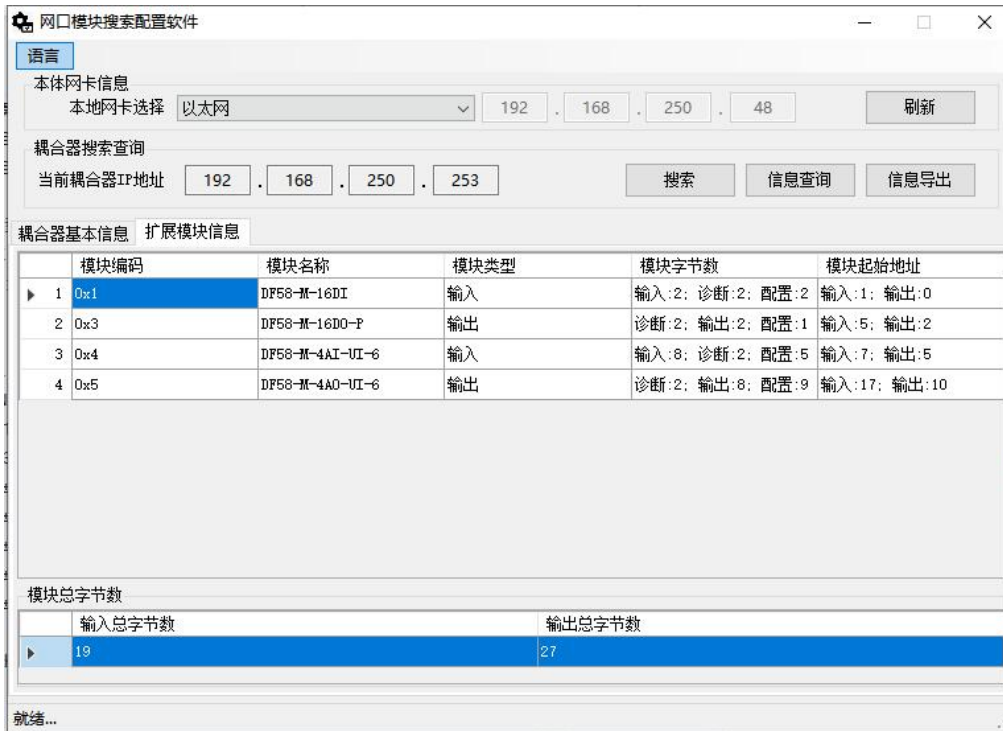

Each extended output address consists of output + configuration. The information queried from the NetModuleSearch tool can be used for address arrangement. This time, the configuration address is Output[0..26] OF BYTE.

**Note: DF58-M-4AO-UI-6 channel 1~4 is configured with 0 by default (output disabled), please configure the channel before using it.**

名称	在线值	修改	注释	数据类型	分配到	显示格式
▼ Output[0..26]				array[0..26] of byte		
Output[0]	00			byte		Hexadecim: ▼
Output[1]	00			byte		Hexadecim: ▼
Output[2]	FF	ff		byte		Hexadecim: ▼
Output[3]	FF	ff		byte		Hexadecim: ▼
Output[4]	00			byte		Hexadecim: ▼
Output[5]	00			byte		Hexadecim: ▼
Output[6]	00			byte		Hexadecim: ▼
Output[7]	00			byte		Hexadecim: ▼
Output[8]	00			byte		Hexadecim: ▼
Output[9]	01	1		byte		Hexadecim: ▼
Output[10]	80	80		byte		Hexadecim: ▼
Output[11]	3E	3e		byte		Hexadecim: ▼
Output[12]	40	40		byte		Hexadecim: ▼
Output[13]	1F	1f		byte		Hexadecim: ▼
Output[14]	00	00		byte		Hexadecim: ▼
Output[15]	7D	7d		byte		Hexadecim: ▼
Output[16]	80	80		byte		Hexadecim: ▼
Output[17]	3E	3e		byte		Hexadecim: ▼
Output[18]	00			byte		Hexadecim: ▼
Output[19]	00			byte		Hexadecim: ▼
Output[20]	00			byte		Hexadecim: ▼
Output[21]	00			byte		Hexadecim: ▼
Output[22]	06	6		byte		Hexadecim: ▼
Output[23]	04	4		byte		Hexadecim: ▼
Output[24]	05	5		byte		Hexadecim: ▼
Output[25]	00	0		byte		Hexadecim: ▼
Output[26]	00			byte		Hexadecim: ▼

Model	region	address	data	illustrate
DF58-M-16DI-P/N	Parameter configuration area	Output[0]	0	Set the filter parameters of input channels 1~8 to no filter
		Output[1]	0	Set the filtering parameters of input channels 9~16 to no filter
DF58-M-16DO-P	Output area	Output[2]	0xFF	Q0.0~Q0.7 full output 1
		Output[3]	0xFF	Q1.0~Q1.7 all output 1
	Parameter configuration area	Output[4]	0	When the communication is disconnected, the disconnection output function is set to the output to keep the state before disconnection
DF58-M-4AI-UI-6	Parameter configuration area	Output[5]~Output[6]	0	Set the sampling period
		Output[7]	0	Reserve.
		Output[8]	0x0	Set the input channel 1~2 with a range of -10V~10V
		Output[9]	0x1	Set the input channel 3~4 with a range of 0~10V
DF58-M-4AO-UI-6	Output area	Output[10]	0x80	channel 1 output address,
		Output[11]	0x3E	0x3E80 (decimal 16000)
		Output[12]	0x40	channel 2 output address,
		Output[13]	0x1F	0x1F40 (decimal 8000)
		Output[14]	0x00	channel 3 output address,



Model	region	address	data	illustrate
		Output[15]	0x7D	Output 0x7D00 (decimal 32000)
		Output[16] Output[17]	0x80 0x3E	channel 4 output address, The output 0x3E80 (decimal 16000), because channel 4 is set to disable, there is actually no output.
	Parameter configuration area	Output[18]	0	reserve
		Output[19]	0	The output setting of the module when the communication is disconnected
		Output[20] Output[21]	0x80 0x3E	0x3E80 set output preset value 16000 (decimal)
		Output[22]	0x06	Set the output range of channel 1 to -10V~10V.
		Output[23]	0x04	Set the output range of channel 2 to 0~10V.
		Output[24]	0x05	Set the output range of channel 3 to 2~10V.
		Output[25]	0x00	Set the output range of channel 4 to disable.
		Output[26]	0	reserve

### 4.1.10.2. Input Area

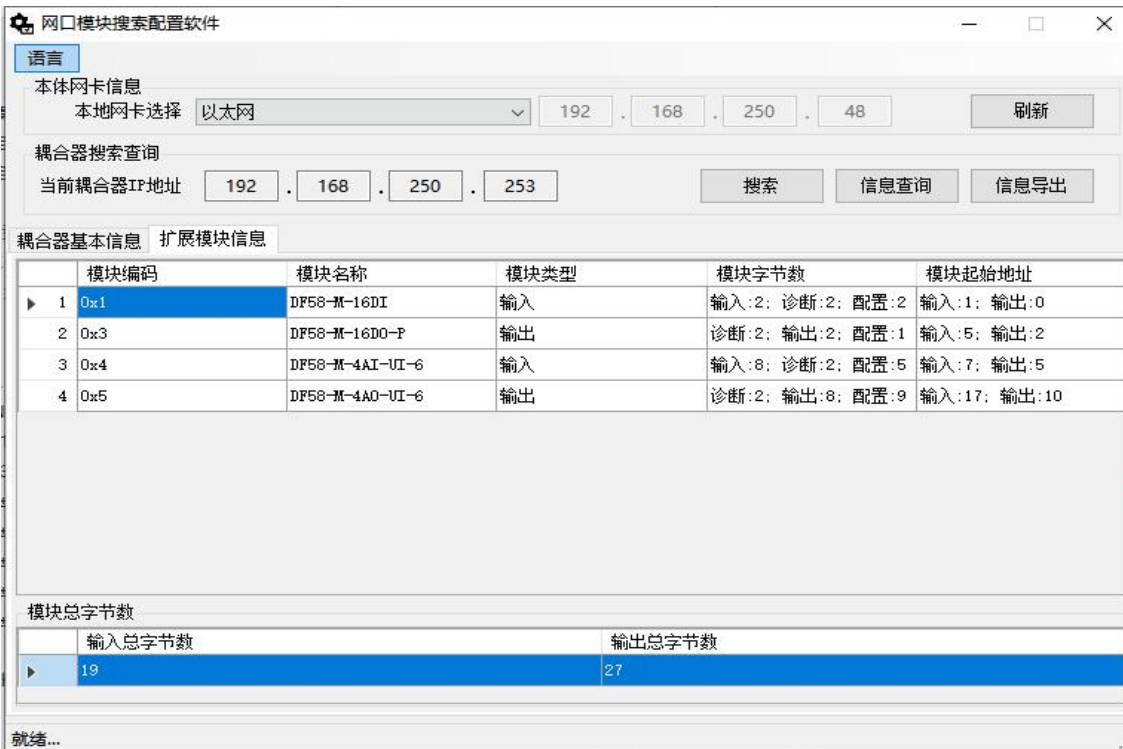

Each extended output address consists of output + configuration. The information queried from the

NetModuleSearch tool can be used for address arrangement. This time, the configuration address is

Input[[0..18] OF BYTE.

▼ Input[0..18]				array[0..18] of byte		
Input[0]	01			byte		Hexadecimal ▼
Input[1]	0F			byte		Hexadecimal ▼
Input[2]	00			byte		Hexadecimal ▼
Input[3]	00			byte		Hexadecimal ▼
Input[4]	00			byte		Hexadecimal ▼
Input[5]	00			byte		Hexadecimal ▼
Input[6]	00			byte		Hexadecimal ▼
Input[7]	5B			byte		Hexadecimal ▼
Input[8]	3E			byte		Hexadecimal ▼
Input[9]	A5			byte		Hexadecimal ▼
Input[10]	12			byte		Hexadecimal ▼
Input[11]	E7			byte		Hexadecimal ▼
Input[12]	7C			byte		Hexadecimal ▼
Input[13]	00			byte		Hexadecimal ▼
Input[14]	00			byte		Hexadecimal ▼
Input[15]	00			byte		Hexadecimal ▼
Input[16]	00			byte		Hexadecimal ▼
Input[17]	00			byte		Hexadecimal ▼
Input[18]	00			byte		Hexadecimal ▼

Model	region	address	data	illustrate
DF58-C-EN-IP	input	Input[0]	0x01	The DF58-C-EN-IP has a signal input for I0.0
DF58-M-16DI-P/N	input	Input[1]	0x0F	DF58-M-16DI-P/N の I0.0~0.4 There is a signal input
		Input[2]	0	
	Diagnostic information	Input[3]	0	The bus is normal
		Input[4]	0	
DF58-M-16DO-P	Diagnostic information	Input[5]	0	The bus is normal
		Input[6]	0	
DF58-M-4AI-UI-6	input	Input[7]	0x5B	Channel 1 Input Data:
		Input[8]	0x3E	0x3E5B (decimal 15963)
		Input[9]	0xA5	Channel 2 Input Data:
		Input[10]	0x12	0x12A5 (decimal 4773)
	input	Input[11]	0xE7	Channel 3 Input Data:
		Input[12]	0x7C	0x7CE7(十进制 31975)
	Diagnostic	input	Input[13]	0
Input[14]			0	
	Diagnostic	Input[15]	0	The bus is normal

Model	region	address	data	illustrate
	information	Input[16]		
DF58-M-4AO-UI-6	Diagnostic information	Input[17]	0	The bus is normal
		Input[18]		

If you manually unplug 4 expansion modules, the diagnosis information is shown in the following

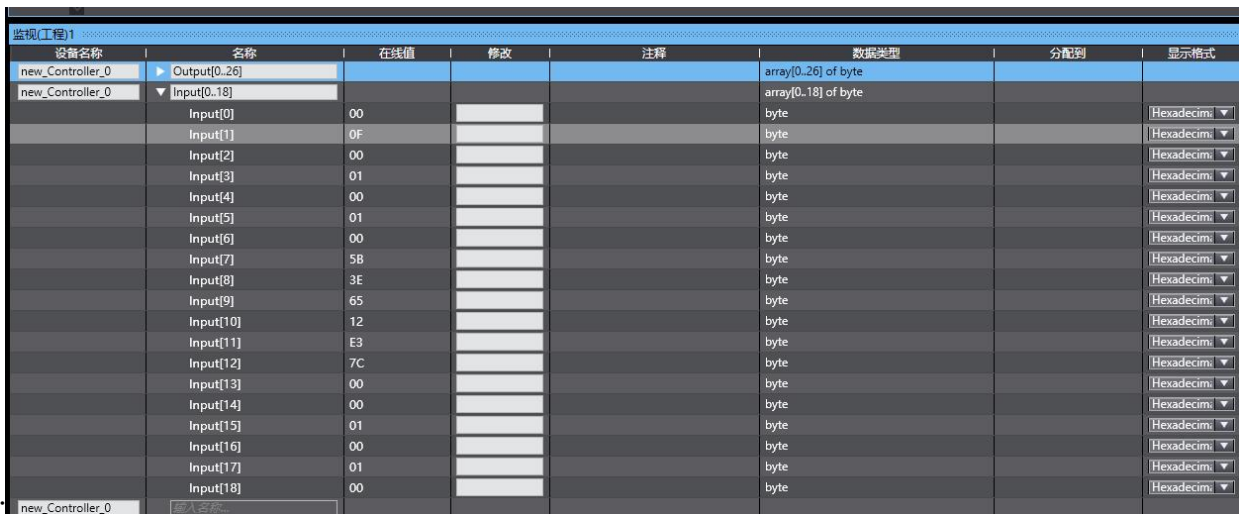

figure:

Model	region	address	data	illustrate
DF58-C-EN-IP	input	Input[0]	0x01	
DF58-M-16DI-P/N	input	Input[1]	0x0F	
		Input[2]	0	
	Diagnostic information	Input[3]	0x01	Bus failure
Input[4]		0		
DF58-M-16DO-P	Diagnostic information	Input[5]	0x01	Bus failure
		Input[6]	0	
DF58-M-4AI-UI-6	input	Input[7]	0x5B	
		Input[8]	0x3E	
		Input[9]	0xA5	
		Input[10]	0x12	
		Input[11]	0xE7	
		Input[12]	0x7C	
	Diagnostic information	Input[13]	0	
		Input[14]	0	
DF58-M-4AO-UI-6	Diagnostic information	Input[15]	0x01	Bus failure
		Input[16]		

---

Model	region	address	data	illustrate
	information	Input[18]		

## 5. Appendix I.----- Use of NetModuleSearch Tools

The NetModuleSearch tool is used to search for the corresponding address of DF58-C-EN-IP and extended IO, which is convenient for programming, and the software supports Chinese and English switching. The local NIC selects the computer-side Ethernet connected to the coupler, and the network segment of the Ethernet network is consistent with the coupler's requirements. Click on the search screen:



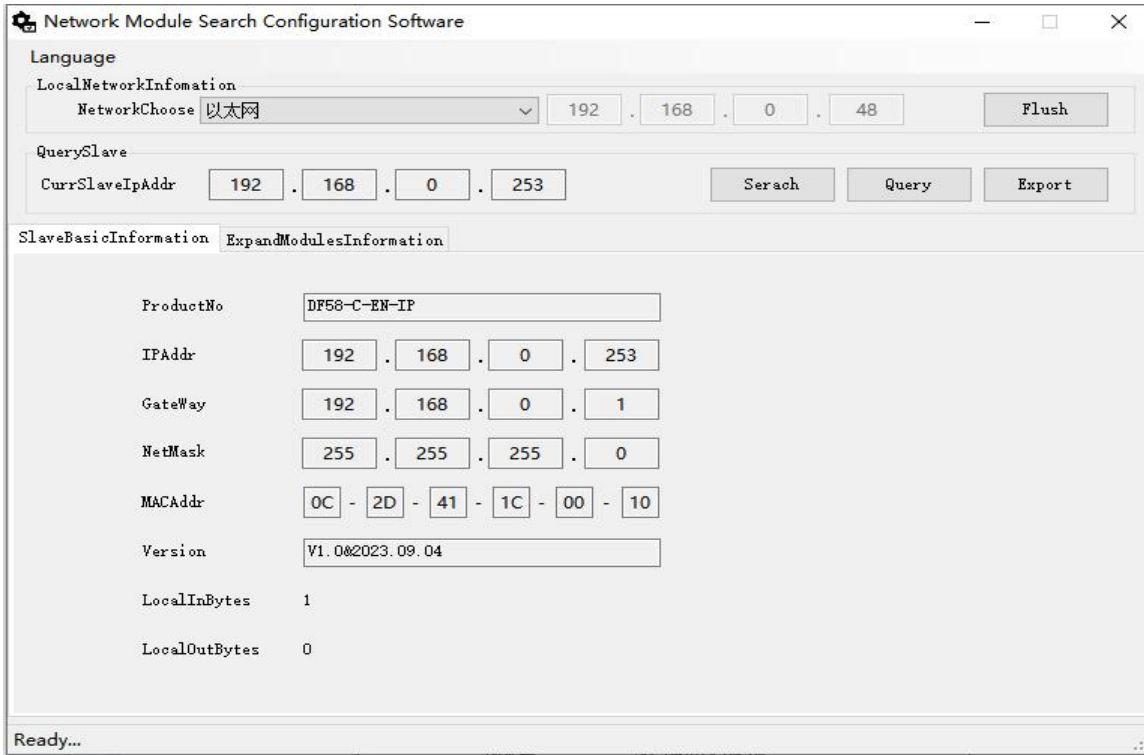

Click Extension Module Information to view the number of bytes and the starting address of each extension module, and the total number of bytes of input and output of the module.

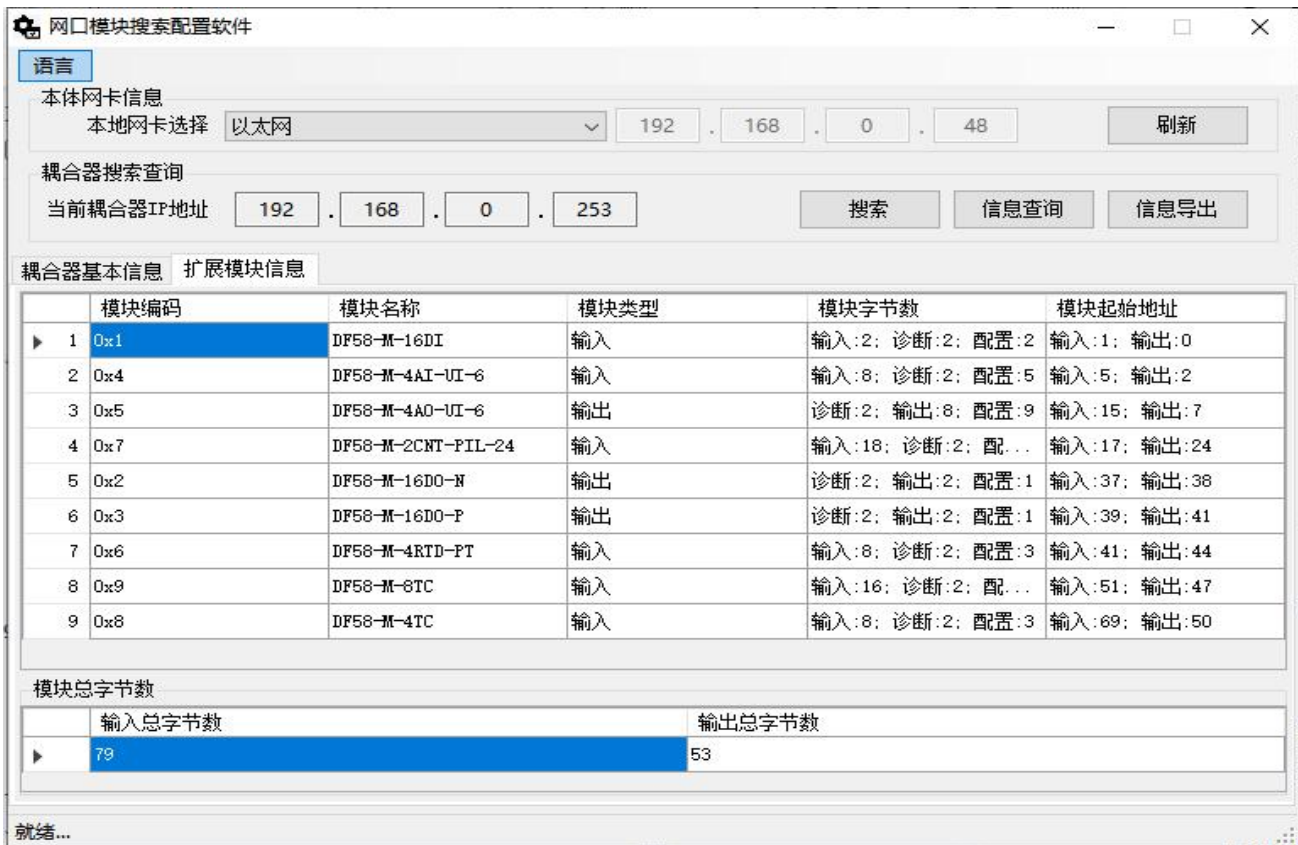

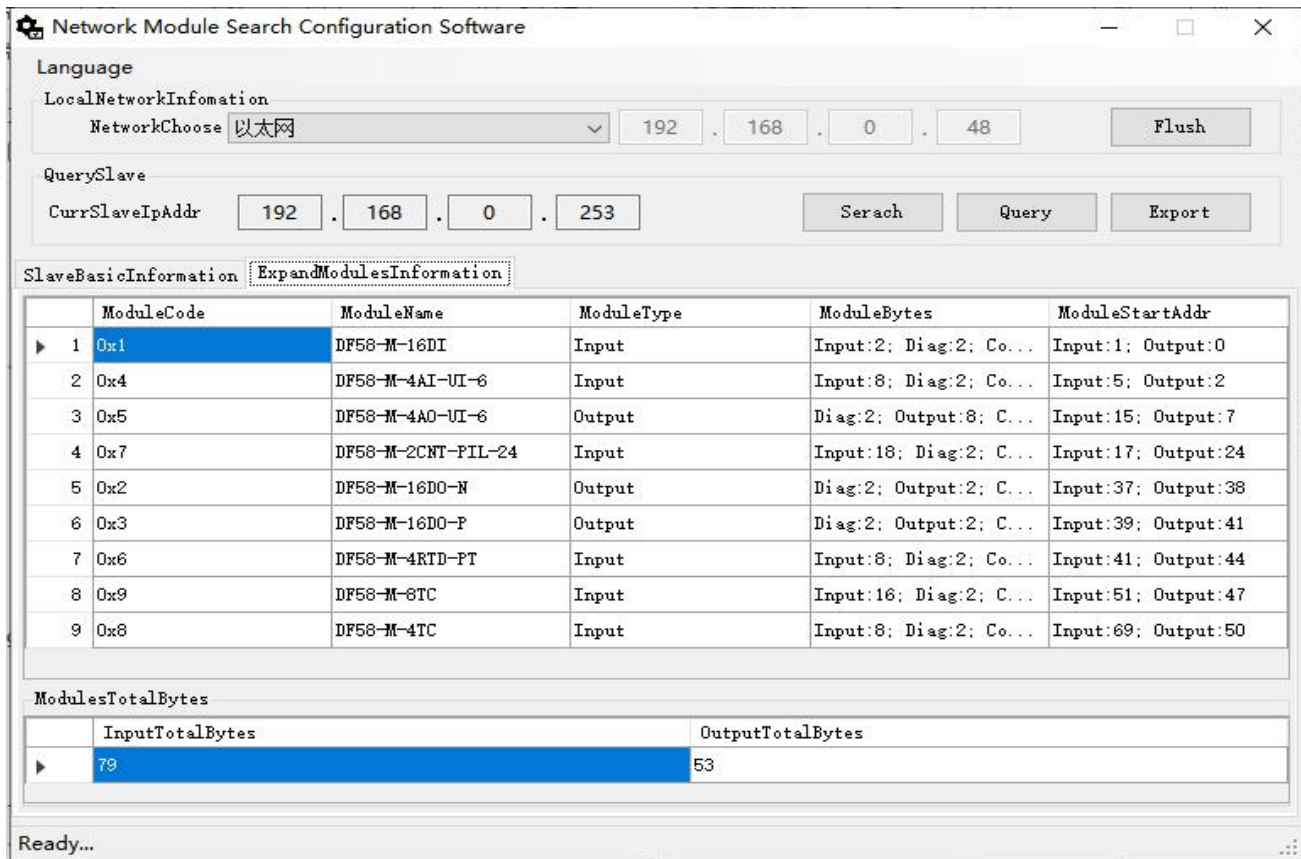

Click Export to export the information.

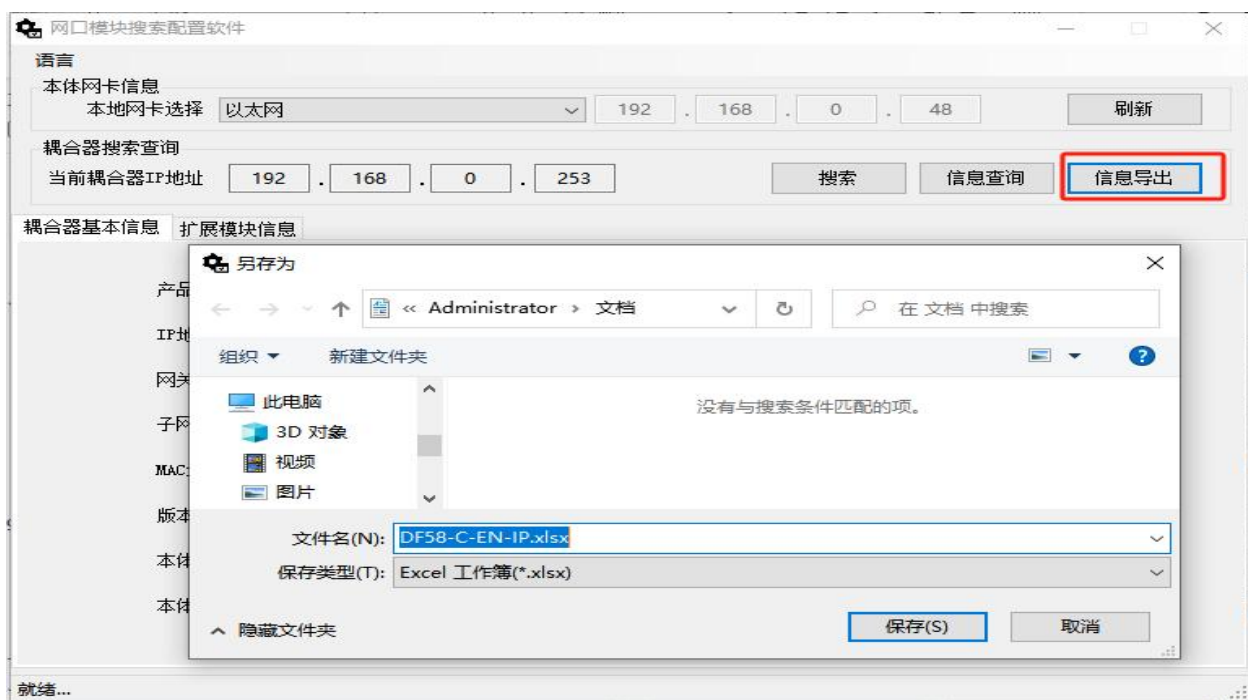

The information is shown in the figure, and the following interfaces for information export are the



English interface and the Chinese interface:

A	B	C	D	E	F	G
1 Product No	DF58-C-EN-IP					
2						
3 IP Addr	Gateway	Netmask	MAC Addr	Local Inp	Local Output Bytes	
4 192.168.0.253	192.168.0.1	255.255.255.0	0C-2D-41-	1	0	
5						
6 Input Total Bytes	Output Total Bytes					
7 79	53					
8						
9						
0 ModuleCode	ModuleName	ModuleType	ModuleByte	ModuleStartAddr		
1 0x1	DF58-M-16DI	Input	Input:2;	Input:1; Output:0		
2 0x4	DF58-M-4AI-UI-6	Input	Input:8;	Input:5; Output:2		
3 0x5	DF58-M-4AO-UI-6	Output	Diag:2;	Input:15; Output:7		
4 0x7	DF58-M-2CNT-FIL-24	Input	Input:18;	Input:17; Output:24		
5 0x2	DF58-M-16DO-M	Output	Diag:2;	Input:37; Output:38		
6 0x3	DF58-M-16DO-P	Output	Diag:2;	Input:39; Output:41		
7 0x6	DF58-M-4RTD-PT	Input	Input:8;	Input:41; Output:44		
8 0x9	DF58-M-8TC	Input	Input:16;	Input:51; Output:47		
9 0x8	DF58-M-4TC	Input	Input:8;	Input:69; Output:50		
10						
11						
12						
13						
14						

A	B	C	D	E	F	G	H
1 产品型号	DF58-C-EN-IP						
2							
3 IP地址	网关	子网掩码	MAC地址	本地输入字节	本地输出字节		
4 192.168.0.253	192.168.0.1	255.255.255.0	0C-2D-41-	1	0		
5							
6 输入总字节数	输出总字节数						
7 79	53						
8							
9							
10 模块编码	模块名称	模块类型	模块字节数	模块起始地址			
11 0x1	DF58-M-16DI	输入	输入:2;	输入:1; 输出:0			
12 0x4	DF58-M-4AI-UI-6	输入	输入:8;	输入:5; 输出:2			
13 0x5	DF58-M-4AO-UI-6	输出	诊断:2;	输入:15; 输出:7			
14 0x7	DF58-M-2CNT-FIL-24	输入	输入:18;	输入:17; 输出:24			
15 0x2	DF58-M-16DO-M	输出	诊断:2;	输入:37; 输出:38			
16 0x3	DF58-M-16DO-P	输出	诊断:2;	输入:39; 输出:41			
17 0x6	DF58-M-4RTD-PT	输入	输入:8;	输入:41; 输出:44			
18 0x9	DF58-M-8TC	输入	输入:16;	输入:51; 输出:47			
19 0x8	DF58-M-4TC	输入	输入:8;	输入:69; 输出:50			
20							
21							
22							
23							

## 6. Appendix II.----- Overview of the bytes of the module

The name of the module	Enter the number of bytes	Number of bytes output	Module ID
DF58-M-16DI	4	2	1
DF58-M-16DO-N	2	3	2
DF58-M-16DO-P	2	3	3
DF58-M-4AI-UI-6	10	5	4
DF58-M-4AO-UI-6	2	17	5
DF58-M-4RTD-PT	10	3	6
DF58-M-2CNT-PIL-24	20	14	7
DF58-M-4TC	10	3	8
DF58-M-8TC	18	3	9